



M-5900RV

Direct Thermal Printer



Operator and Technical Reference Manual

SATO America, Inc.
10350-A Nations Ford Rd.
Charlotte, NC 28273
Main Phone: (704) 644-1650
Technical Support Hotline: (704) 644-1660
Fax: (704) 644-1661
<http://www.satoamerica.com>

© Copyright 2000
SATO America, Inc.

Warning: This equipment complies with the requirements in Part 15 of FCC rules for a Class A computing device. Operation of this equipment in a residential area may cause unacceptable interference to radio and TV reception requiring the operator to take whatever steps are necessary to correct the interference.

All rights reserved. No part of this document may be reproduced or issued to third parties in any form whatever without the express permission of SATO America, Inc. The materials in this document are provided for general information and are subject to change without notice. SATO America, Inc. assumes no responsibility for any errors that may appear.

Preface

M-5900RV Operator and Technical Reference Manual

The M-5900RV Operator and Technical Reference Manual contains basic information about the printer such as setup, installation, cleaning and maintenance. It also contains complete instructions on how to use the operator panel to configure the printer. The following is a brief description of each section in this manual.

Section 1. Printer Overview

This section contains a discussion of the printer specifications and optional features.

Section 2. Installation and Configuration

This section contains instructions on how to unpack and set up the printer, load the labels, and how to use the operator panel to configure the printer.

Section 3. Adjustments and Maintenance

This section contains instruction on how to maintain and adjust the printer.

Section 4. Programming Reference

This section introduces the SATO Printer Programming Language. It contains the commands that are used with the printer to produce labels with bar codes, alphanumeric data and graphics.

Section 5. Interface Specifications

This section contains the printer's interface specifications, which include detailed information on how to properly interface your printer to the host system.

Section 6. Troubleshooting

This section contains troubleshooting procedures to follow in the event you have printer problems.

Appendices

<i>Appendix A:</i>	<i>Command Code Quick Reference</i>
<i>Appendix B:</i>	<i>Bar Code Specifications</i>
<i>Appendix C:</i>	<i>Custom Characters and Graphics</i>
<i>Appendix D:</i>	<i>Optional Features</i>
<i>Appendix E:</i>	<i>Custom Protocol</i>



Table of Contents

Section 1. Overview	Page
1 Introduction	1-1
2 Compatibility	1-2
3 General Printer Specifications	1-3
4 Character Fonts	1-6
5 Bar Codes	1-7
6 Physical Specifications	1-8
7 Optional Accessories	1-8

Section 2. Installation and Configuration

1 Introduction	2-1
2 Unpacking and Parts Identification	2-2
3 Setting Up the M-5900RV	2-3
4 Printer Features	2-4
5 Operator Panel	2-7
6 Rear Panel	2-8
7 Loading Labels or Tags	2-9
8 DIP Switch Settings	2-13
9 Default Settings	2-19
10 Printer Adjustments	2-20
11 Advanced Mode	2-24
12 Printing Test Labels	2-36
13 Hex Dump Diagnostic Labels	2-38
14 Potentiometer Adjustments	2-40

Section 3. Adjustments and Maintenance

1 Introduction	3-1
2 Adjusting the Print Quality	3-1
Darkness	3-1
Print Speed	3-2
3 Cleaning the Print Head and Platen	3-3
Print Head	3-3
Platen	3-5
4 Replacing the Print Head	3-6

Section 4. Programming Reference

1 Introduction	4-1
2 The SATO RISC Programming Language	4-1
3 Selecting Protocol Control Codes	4-2
4 Using Basic	4-3
5 The Print Area	4-5
6 Rotated Fields	4-10

Table of Contents

Section	4. Programming Reference	Page
7	Command Default Settings	4-11
8	Command Codes	4-12
	Bar Codes	4-13
	Bar Codes, Expansion	4-18
	Bar Codes, Variable Ratio.....	4-19
	Base Reference Point	4-21
	Characters, Custom Designed	4-23
	Character Expansion	4-25
	Character, Fixed Spacing	4-27
	Character Pitch	4-28
	Character, Proportional Spacing	4-30
	Clear Print Job(s) and Memory	4-31
	Continuous Forms Printing	4-32
	Copy Image Area	4-33
	Cutter Command	4-35
	Fonts, U, S, M, OA, OB, XU, XS and XM	4-36
	Fonts, Vector	4-38
	Fonts, WB, WL, XB and XL	4-40
	Form Feed	4-42
	Form Overlay Recall.....	4-43
	Form Overlay Store	4-44
	Graphics, Custom	4-45
	Graphics, PCX	4-47
	Job ID Store	4-48
	Journal Print	4-49
	Lines and Boxes	4-50
	Line Feed.....	4-52
	Mirror Image.....	4-54
	Off-Line/Pause	4-56
	Postnet	4-57
	Print Darkness	4-58
	Print Length, Expanded	4-59
	Print Position	4-61
	Print Quality	4-63
	Print Speed	4-64
	Repeat Label	4-65
	Replace Data (Partial Edit).....	4-66
	Reverse Image	4-68
	Rotate, Fixed Base Reference Point.....	4-70
	Rotate, Moving Base Reference Point.....	4-72
	Sequential Numbering	4-74
	Start/Stop Label.....	4-76
	Calendar Increment.....	4-77
	Calendar Print.....	4-79
	Calendar Set	4-81

Table of Contents

Section 4. Programming Reference	Page
9 Memory Card Option Commands	4-82
Clear Card Memory	4-82
Expand Memory Area	4-83
Fonts, TrueType Recall	4-85
Fonts, TrueType Store	4-86
Format/Field Recall	4-87
Format/Field Store	4-88
Graphics, Custom Recall	4-89
Graphics, Custom Store	4-90
Graphics, PCX Recall	4-92
Graphics, PCX Store	4-93
Initialize	4-94
Slot Select	4-95
Status	4-96
Custom Protocol Codes Download	4-97
10 Two-Dimensional Symbols	4-99
Data Matrix, Data Format	4-99
Data Matrix, Print Data	4-101
Data Matrix, Sequential Numbering	4-102
Maxicode	4-104
PDF417	4-106

Section 5. Interface Specifications	
1 Introduction	5-1
2 Interface Types	5-1
3 The Receive Buffer	5-3
4 RS232C Serial Interface	5-4
General Specifications	5-4
Electrical Specifications	5-4
Pin Assignments	5-5
Ready/Busy Flow Control	5-5
X-On/X-Off Flow Control	5-6
Bi-Directional Communications	5-7
5 Centronics Parallel Interface	5-11
Electrical Specifications	5-11
6 Accessory (EXT) Connector	5-12
Pin Assignments	5-12
External Output Signals	5-13

Section 6. Troubleshooting	
1 Initial Checklist	6-1
2 Using the Centronics (Parallel) Interface	6-2
3 Using the RS232C (Serial) Interface	6-4
4 Error Signals	6-5
5 Diagnosing and Correcting Specific Problems	6-6

Table of Contents

Appendices

	Page
APPENDIX A: Command Code Quick Reference	A-1
APPENDIX B: Bar Code Specifications	
Bar Code Symbolologies	B-1
Codabar	B-2
Code 39.....	B-3
Interleaved Two of Five (1 2/5)	B-4
UPC-A/EAN-13	B-5
EAN-8	B-7
Industrial Two of Five.....	B-8
Matrix Two of Five	B-9
Code 128.....	B-10
MSI	B-11
Code 93.....	B-12
UPC-E	B-13
Bookland (UPC/EAN Supplements)	B-14
UCC-128.....	B-15
Postnet	B-17
Data Matrix	B-18
Maxicode	B-20
PDF417	B-21
Code 128 Character Table	B-22
APPENDIX C: Custom Characters and Graphics	
Custom Designed Characters Exanple	C-1
Custom Graphics Example.....	C-4
PCX Graphics Example.....	C-8
APPENDIX D: Optional Accessories	
Introduction.....	D-1
Label Rewinder	D-1
Label Cutter.....	D-2
Label Dispenser	D-3
PCMCIA Memory Cards	D-4
Plug-in Interface Cards	D-5
Calendar	D-5
APPENDIX E: Custom Protocol Command Codes	
Description	E-1
Download Command Structure	E-1
Reset.....	E-2
Download Procedure.....	E-2

Overview

1.1 Introduction

1.2 Compatibility

NOTE: Even when DSW2-8 is in the ON position, The M-5900RV expects the command sequences to follow the rules specified in the Programming Reference.

STEP	PROCEDURE
	<p data-bbox="1019 1150 1084 1180">OFF</p> <p data-bbox="386 1360 1328 1470"><i>If you resend the label to the printer, any old software commands will override the changes you made with the LCD controls.</i></p>

Compatibility

STEP	PROCEDURE
	ON

1.3 General Printer Specifications

SPECIFICATION	M-5900RV
Print	
Method	Direct Thermal only
Speed (User Selectable)	2 to 4.7 ips (Default 3 ips - 75 mm/s) 50 to 120 mm/s
Print Module (Dot Size)	.0049 in .125 mm
Resolution	203 dpi 8 dpmm
Print Darkness	5 steps selectable
Maximum Print Width	4.4 in. 112 mm
Maximum Print Length (Expanded Print Length)	14 in. 356 mm
Maximum Print Length with 2MB Memory Card	49.2 in. 1249 mm

General Printer Specifications

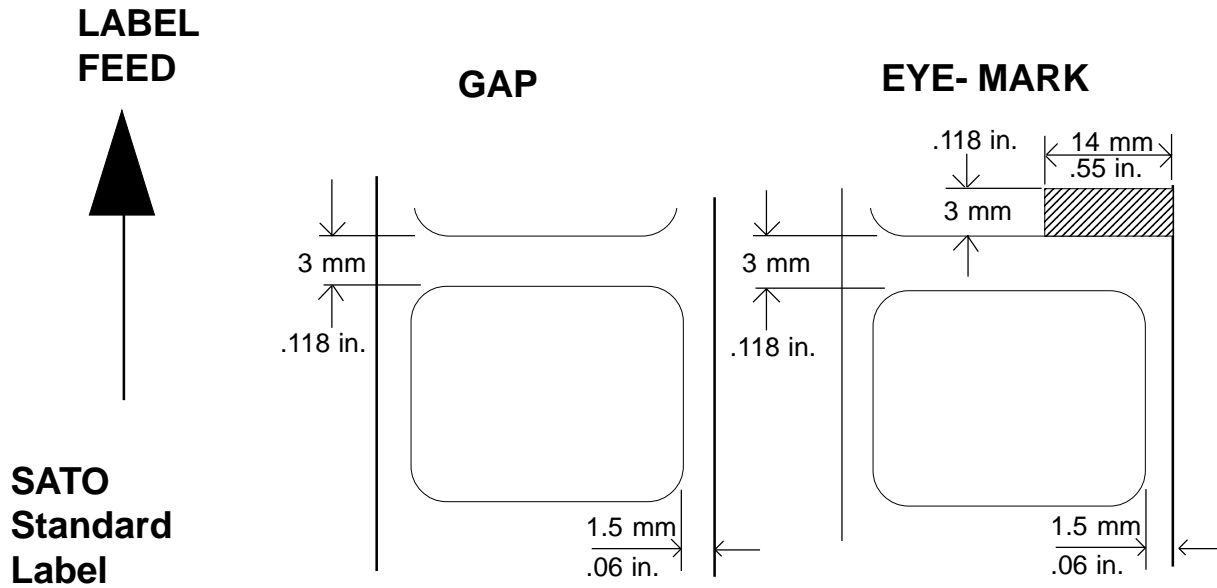

Batch	Size	Width: 1.46 in. to 5.04 in. (1.57 in. to 5.16 in. including backing paper) 37 mm to 128 mm (40 mm to 131 mm including backing paper) Length: .98 in. to 14 in. (1.10 in. to 14.13 in. including backing paper) 25 mm to 356 mm (28 mm to 359 mm including backing paper)
	Caliper	.003 in. to .008 in. (.08 mm to .21 mm)
Dispenser	Caliper	.004 in. to .006 in. (.1 mm to .16 mm)
Cutter	Caliper	.003 in. to .008 in. (.08 mm to .21 mm)
Tear-Off	Caliper	.003 in to .006 in. (.08 mm to .16 mm)

General Printer Specifications

SPECIFICATION	M-5900RV
Media	
Media Type	Die Cut Labels, Fan-Fold, Tag Stock or Continuous Roll OD 6 in. (150 mm), Face-in Wind Roll ID 4 in. (100 mm) Fan-Fold up to 4 in. (100 mm) via rear cover)
Sensing	
See-Thru for labels or tags	Movable
Reflective Eye-Mark	Movable
Continuous Form	Sensor not used
Self-Diagnostics Function	Head Check, Paper end, Head open, Self test print, Memory Card error
Potentiometer Adjustments	
Print Darkness	Front Panel
Offset	Front Panel
Pitch	Front Panel
Interface Connections	
Parallel ₍₁₎	Centronics Compatible
Serial ₍₁₎	RS232C (2400 to 19.2K bps) Standard RS422/485 (2400 to 19.2K bps) Optional Hardware Flow Control (Ready/Busy) Software Flow Control (X-On/X-Off) Bi-directional (ENQ/Response)
Universal Serial Bus ₍₁₎	Version 1.1
LAN ₍₁₎	10/100BaseT
EXT Port ₍₁₎	Standard
Data Transmission	ASCII Format
Processing	
CPU	32 Bit RISC
Program ROM	512 KByte x 1
Masked Font ROM	512 KByte x 1
DRAM	2 MByte
Programmable	8 KByte EEPROM
(1) Plug-In Interface Modules	

1.4 Character Fonts

SPECIFICATION	M-5900RV
Matrix Fonts	
U font	(5 dots W x 9 dots H)
S font	(8 dots W x 15 dots H)
M font	(13 dots W x 20 dots H)
XU Font	(5 dots W x 9 dots H) Helvetica
XS Font	(17 dots W x 17 dots H) Univers Condensed Bold
XM Font	(24 dots W x 24 dots H) Univers Condensed Bold
OA Font	(15 dots W x 22 dots H) OCR-A
OB Font	(20 dots W x 24 dots H) OCR-B
Auto Smoothing Fonts	
WB	WB Font (18 dots W x 20 dots H)
WL	WL Font (28 dots W x 52 dots H)
XB	XB Font (48 dots W x 48 dots H) Univers Condensed Bold
XL	XL Font (48 dots W x 48 dots H) Sans Serif
Vector Font	
	Proportional or Fixed Spacing Font Size 50 x 50 dots to 999 x 999 dots Helvetica, 10 Font Variations
Downloadable Fonts	
	TrueType Fonts with Optional Memory Card
Character Control	
	Expansion up to 12X in either the X or Y coordinates Character Pitch control Line Space control Journal Print Facility 0°, 90°, 180° and 270° Rotation

1.5 Bar Codes

SPECIFICATION	M-5900RV
Symbologies	
	Bookland (UPC/EAN Supplemental) EAN-8, EAN-13 CODABAR Code 39 Code 93 Code 128 Interleaved 2 of 5 Industrial 2 of 5 Matrix 2 of 5 MSI POSTNET UCC/EAN-128 UPC-A and UPC-E Data Matrix Maxicode PDF417
Ratios	1:2, 1:, 2:5 user definable bar widths
Bar Height	4 to 600 dots, User programmable
Rotation	0°, 90°, 180° and 270°
Other Features	
Sequential Numbering	Sequential numbering of both numerics and bar codes
Custom Characters	RAM storage for special characters
Graphics	Full dot addressable graphics, SATO Hex/Binary or PCX
Form Overlay	Form overlay for high-speed editing of complex formats

1.6 Physical Specifications

SPECIFICATION

M-5900RV

69 145.1.9854 Td (-)T



1.7 Optional Accessories

Installation and Configuration

2.1 Introduction

This section is provided to assist you in taking the M-5900RV Printer from the shipping container to the application environment.

The following information is provided in this section:

- Unpacking and Parts Identification
- Setting Up the M-5900RV
- Printer Features
- Operator Panel
- Rear Panel
- Loading Labels or Tags
- Dip Switch Settings
- Printer Adjustments
- Printing Test Labels
- Advanced Mode
- Potentiometer Adjustments
- Hex Dump Diagnostic Labels

2.2 Unpacking and Parts Identification

Unpack the printer as follows:

- Place the box upright on a solid, flat surface.
- Open the box and remove any loose items and the first layer of packing material.
- Carefully lift the printer from the box and place it on a solid flat surface. Inspect the shipping container and printer for any signs of damage that may have occurred during shipping.
- Remove the plastic covering from the printer.
- Remove the accessory items from their protective containers.
- If the printer has been stored in a cold environment, allow it to reach room temperature before powering it on.

. NOTE: The following illustrations are representative only. Your printer may not be packed exactly as shown here, but the unpacking steps are similar.



REMOVE PACKING MATERIAL



LIFT THE PRINTER FROM THE BOX CAREFULLY

Unpacking and Parts Identification (Cont)

Verify that you have the following items when unpacking:

- Printer
- Power Cord
- Operator's Manual/Programmer and Technical Reference Manual
- CD containing Label Wizard SE



2.3 Setting Up the M-5900RV

Consider the following when setting up the printer:

- Locate a solid flat surface to set the printer. Make sure there is enough room at the top and right-hand side (facing the printer) to provide clearance for the right side access door to swing open.
- The location should be near the host computer or terminal. The maximum distance for RS232 cables is 50 feet and six feet for Centronics Parallel cables. Cables can be purchased locally, and their configuration will depend upon the host system being used.
- For information on interfacing the printer to a host system, see Section 5: Interface Specifications.

2.4 Printer Features

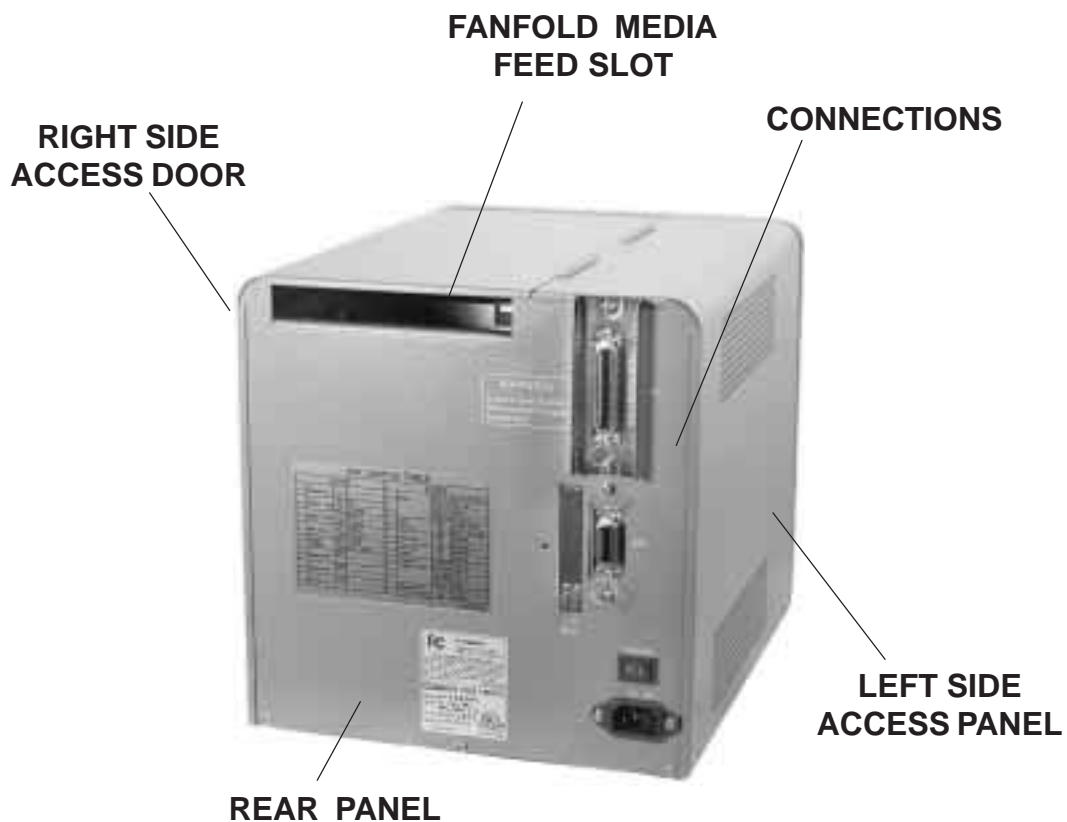
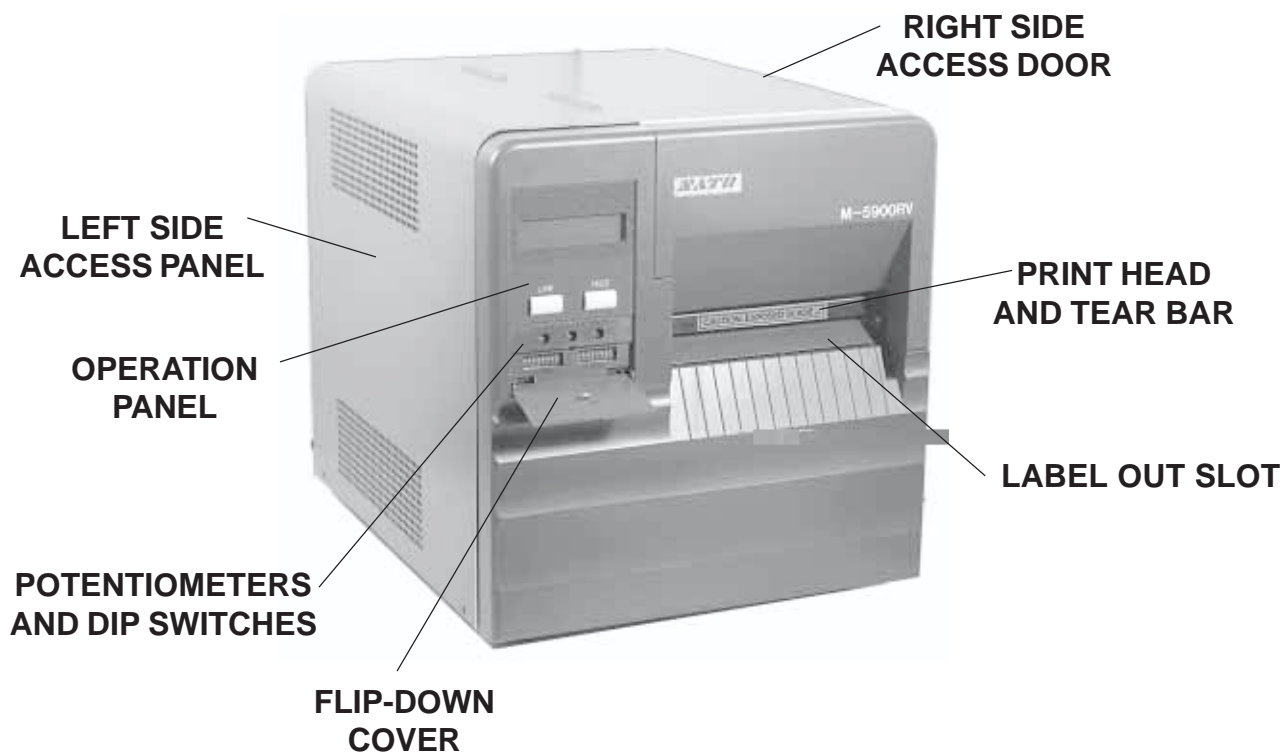

Printer Features

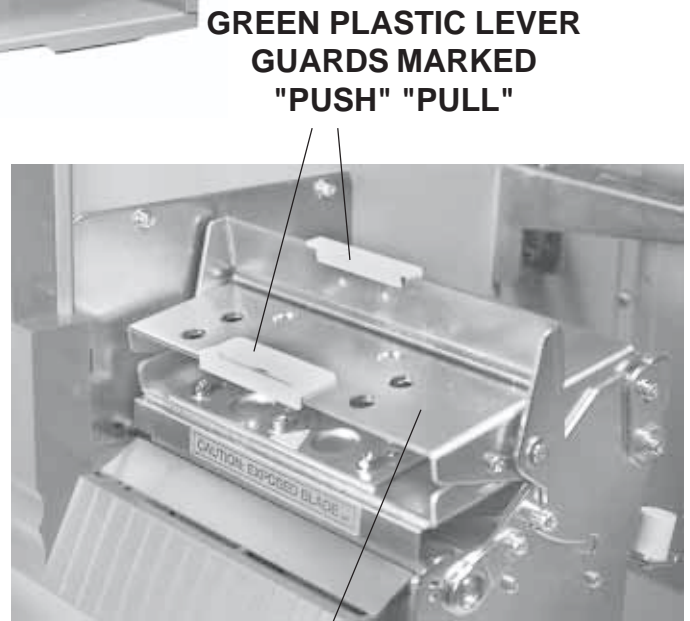
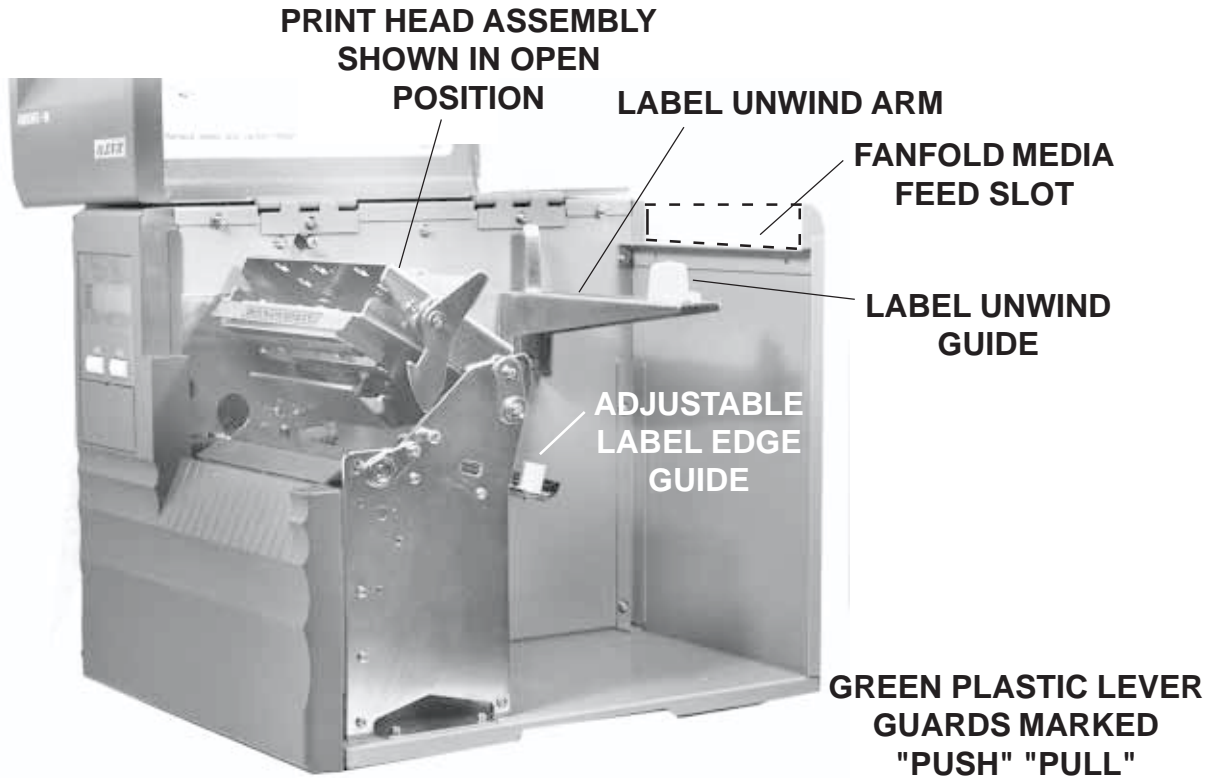

Printer Features

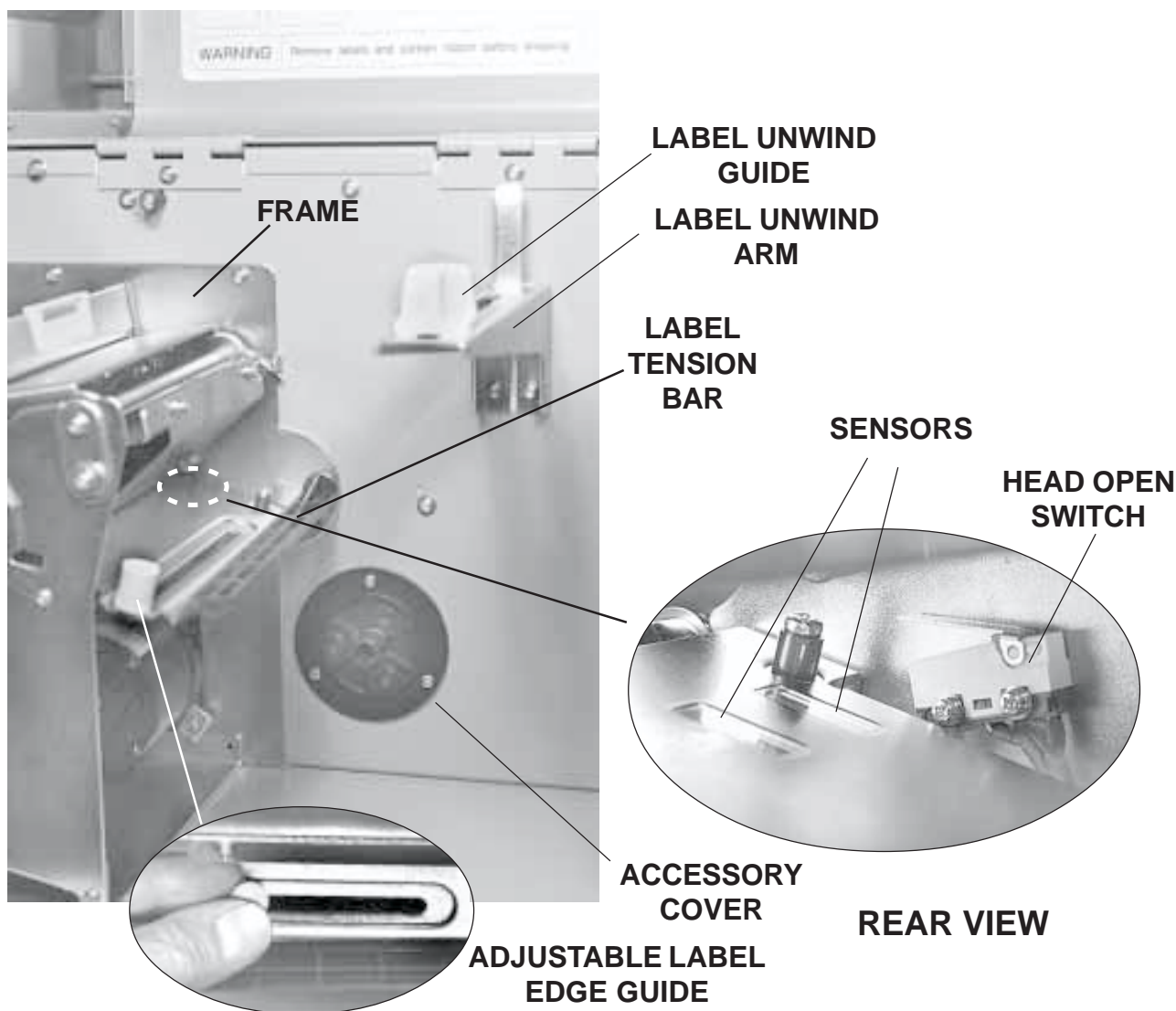
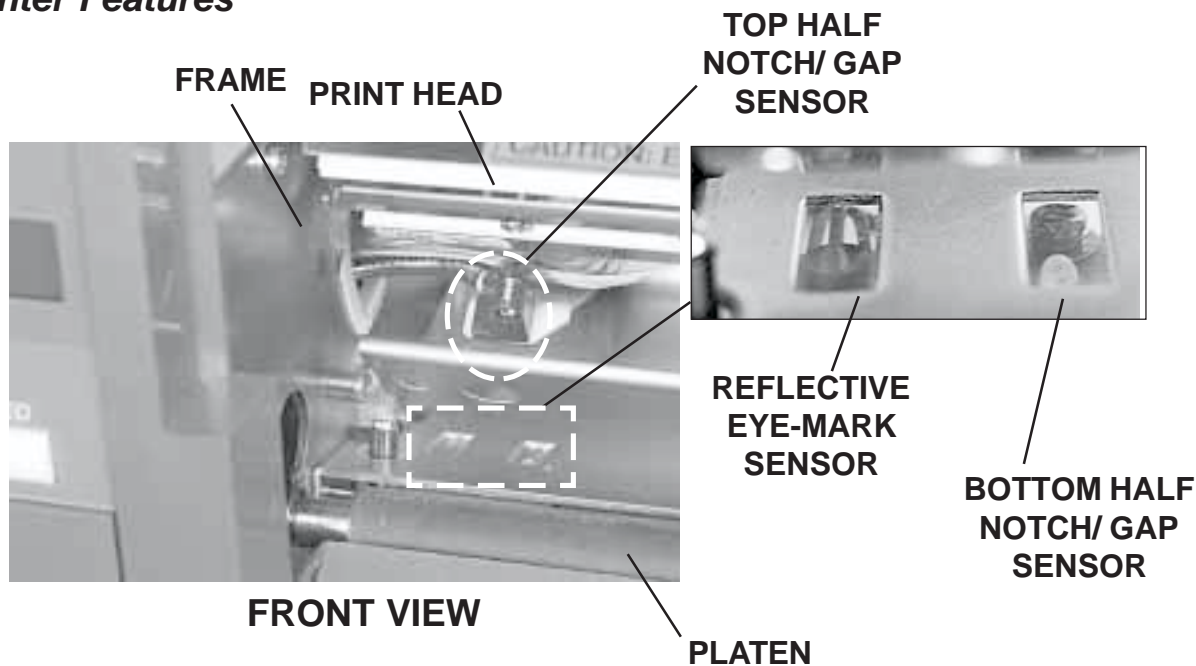

2.5 Operation Panel

The M-5900RV Operation Panel has an LCD screen, user input keys and user adjustable potentiometers and dip switches, which are located underneath a flip-down cover on the operation panel.

The power switch is located at the back of the printer.

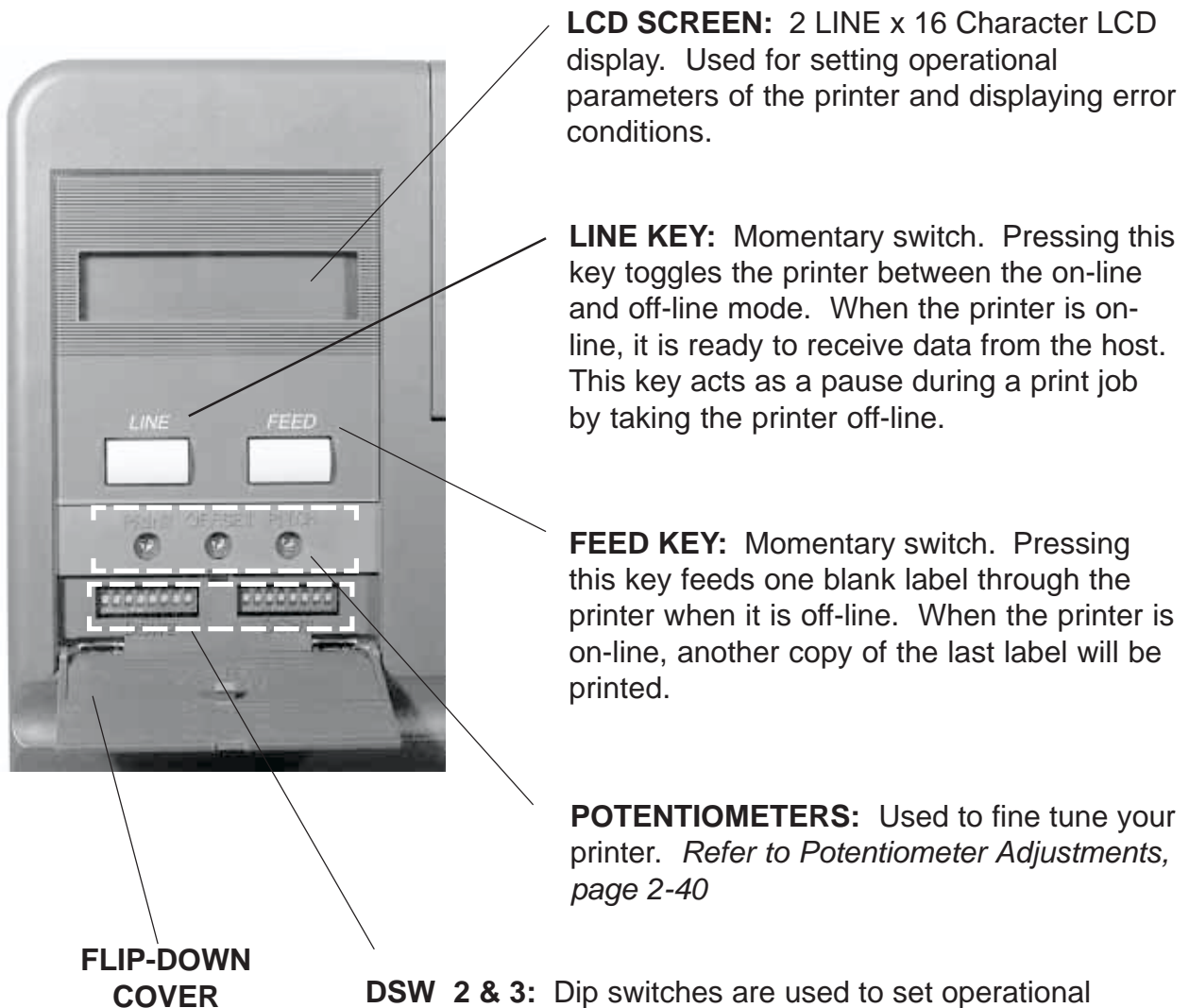

LCD SCREEN: 2 LINE x 16 Character LCD display. Used for setting operational parameters of the printer and displaying error conditions.

LINE KEY: Momentary switch. Pressing this key toggles the printer between the on-line and off-line mode. When the printer is on-line, it is ready to receive data from the host. This key acts as a pause during a print job by taking the printer off-line.

FEED KEY: Momentary switch. Pressing this key feeds one blank label through the printer when it is off-line. When the printer is on-line, another copy of the last label will be printed.

POTENTIOMETERS: Used to fine tune your printer. Refer to *Potentiometer Adjustments*, page 2-40

FLIP-DOWN COVER

DSW 2 & 3: Dip switches are used to set operational parameters of the printer. Refer to *Dip Switch Settings*, page 2-13 through 2-18.

NOTE: DSW 1 is located on the RS232S Serial Interface Card and is used to set transmit/receive parameters. This card is attached to the main PCB board and can be removed to access the switches. Refer to *Dip Switch Settings*, page 2-13, 2-17 and 2-18.

2.6 Rear Panel

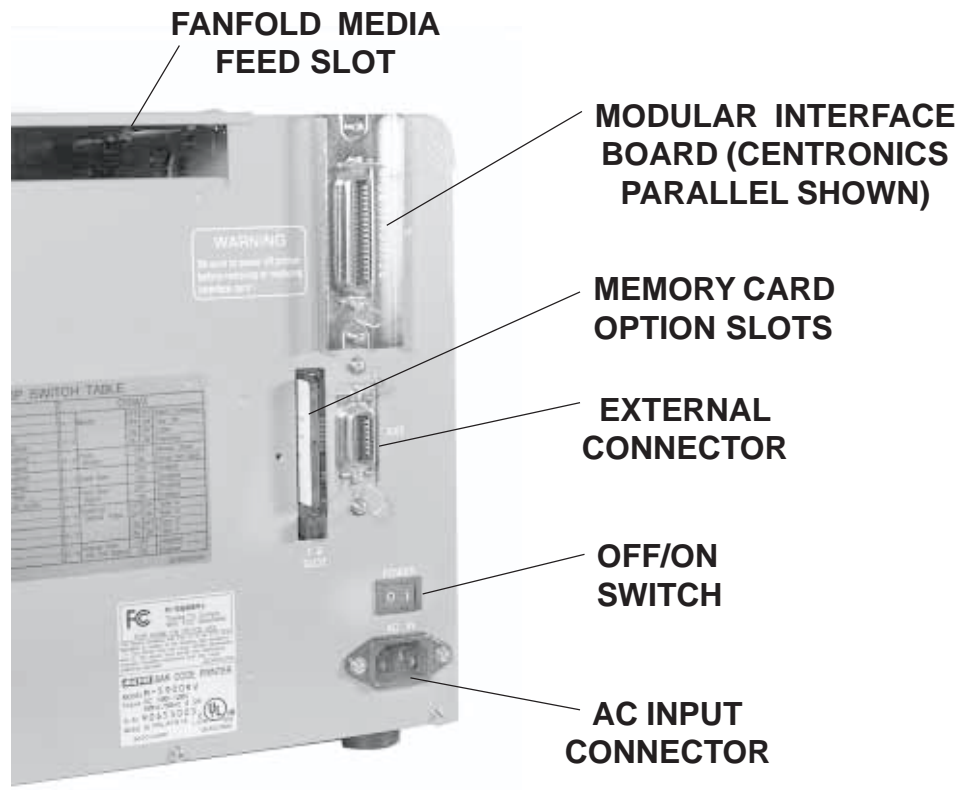

MEMORY CARD OPTION SLOTS:	Two slots for PCMCIA Memory Cards (up to 2MB each)
PLUG - IN INTERFACE MODULES AVAILABLE:	Ethernet, RS232C, RS422/485, Coax/Twinax or Centronics Parallel Universal Serial Bus
POWER ON/OFF SWITCH:	To turn the printer on or off
AC INPUT CONNECTOR:	Connect to 115V 50/60 Hz. with cable provided
EXT. PORT CONNECTOR:	External signal connector

2.7 Loading Labels or Tags

CAUTION: If your labels are less than the full width of the print head, the outside edge will eventually wear out a small portion of the print head, resulting in an area that will not print. Special care must be taken if you plan to use multiple widths of labels since the damaged portion of the print head caused from edge wear on a more narrow label may affect the printing on a wider label. We suggest you plan your print formats carefully to avoid using the area of possible damage on the print head when using a wider label. The small area of damage will have no effect on printing with the undamaged part of the print head.

Damage from a label edge is physical damage and is unavoidable. It is not covered by warranty.

Refer to the following and previous illustrations while loading your media.

STEP	PROCEDURE
1.	Raise the printer right side access door. Page. 2-4
2.	Open the Print Head Assembly by pulling down forward on the green Lever Guard atop the assembly. Page. 2-5
3.	Slide the green plastic Label Unwind Guide to the outside edge of the label. If using roll labels (or tags), load the roll onto the Label Unwind Arm so that the printed side of the label faces upward as it unwinds from the roll. Page. 2-5, 2-6, 2-10, 2-11, 2-12
4.	Push the roll all the way to the inside of the printer, then slide the Label Unwind Guide against the label roll to hold the roll in place. Page. 2-10
5.	If using fanfold labels or tags, set them on a flat surface behind the printer. Locate the Feed Slot opening at the rear of the printer. Pass the labels (printed side up) through the slot and over the Label Unwind Arm. Page. 2-10
6.	Slide the adjustable Label Edge Guide to the outside edge of the bracket. Feed the labels or tags under the Label Tension Bar, through the open Print Head Assembly and out the front of the printer. Set the Adjustable Label Edge Guide to keep the labels against the inside of the printer. <i>NOTE: If the Label Dispenser option has been purchased, see Appendix D, for proper routing instructions. The M-5900RV must be configured for the Label Dispenser Mode for proper operation. Please refer to DIP Switch Settings (page 2-15).</i>

Loading Labels or Tags

STEP	PROCEDURE
	Continued from previous page
7.	Close the Print Head Assembly by pushing down at the front of the plate atop the assembly (green plastic piece marked "PUSH") until the assembly clicks into its locked position. Page 2-11
8.	Close the right side access door.

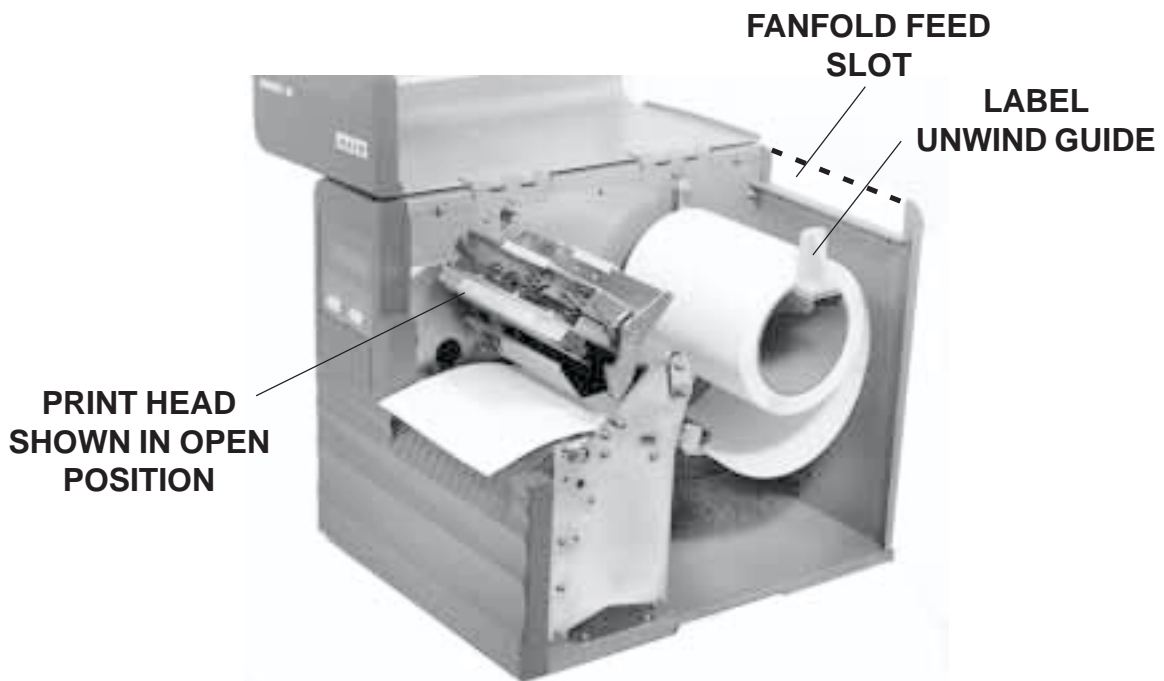
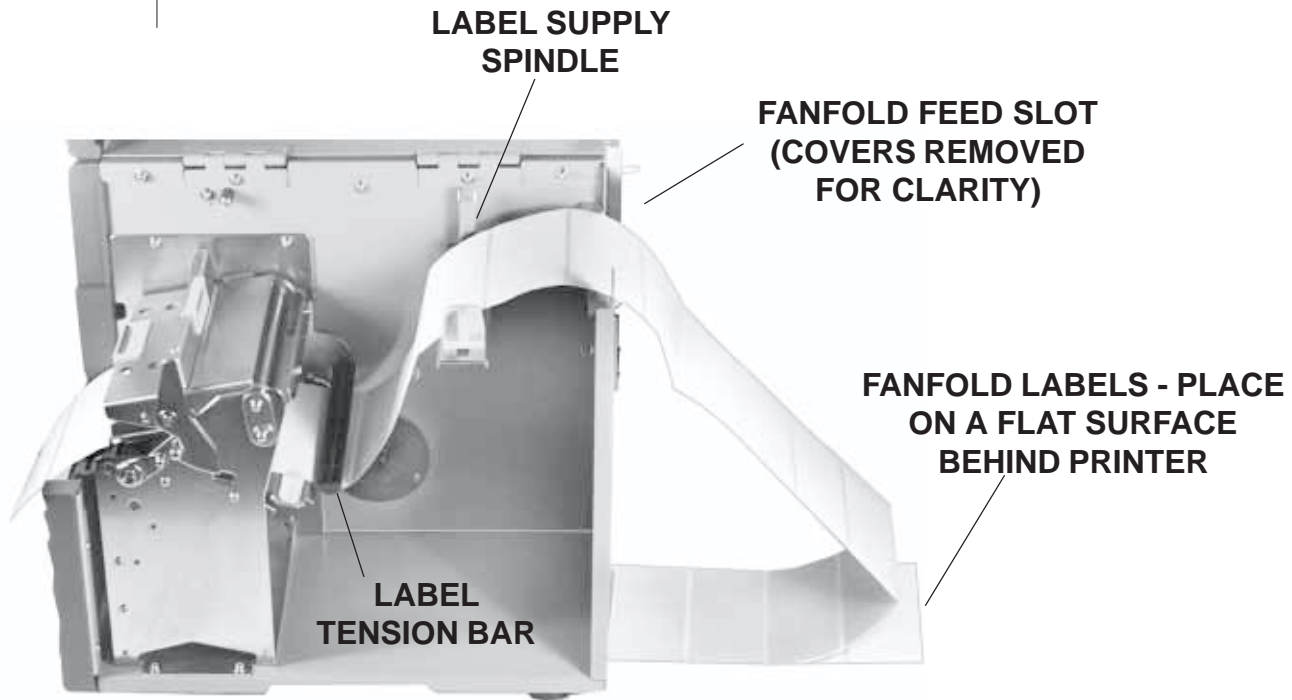

Loading Labels or Tags

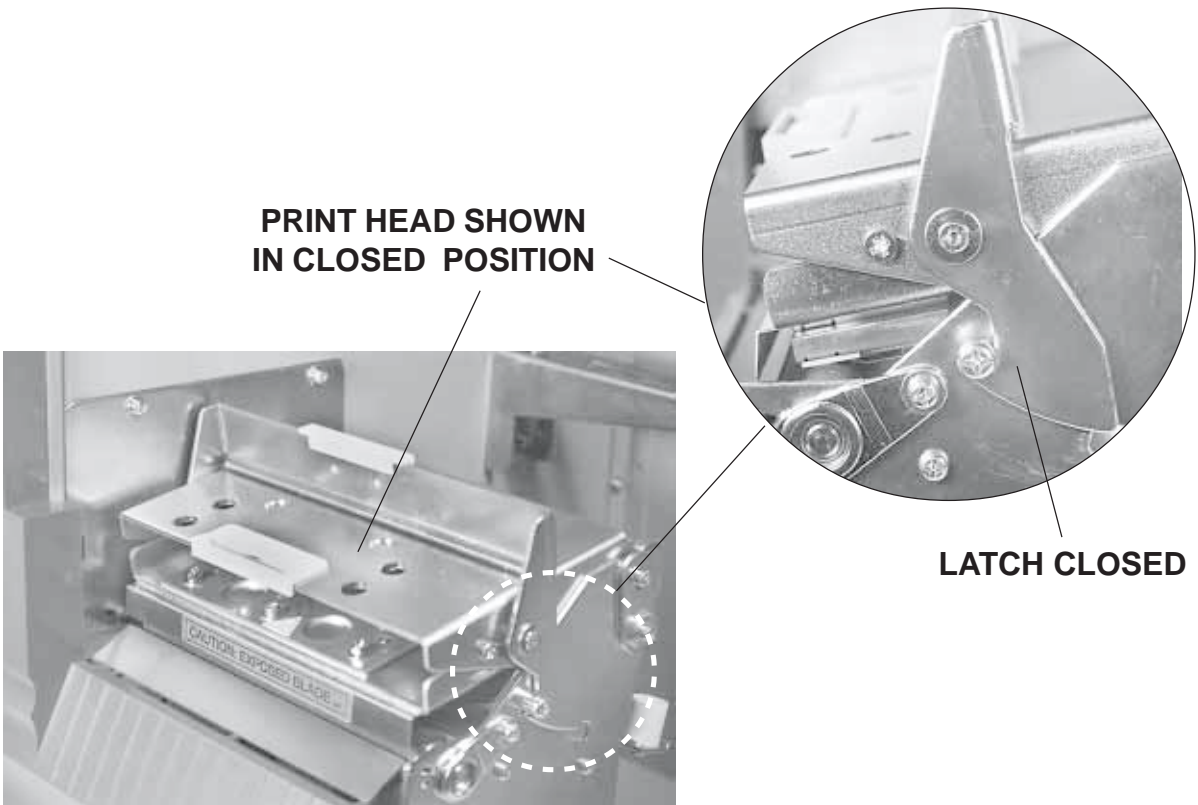
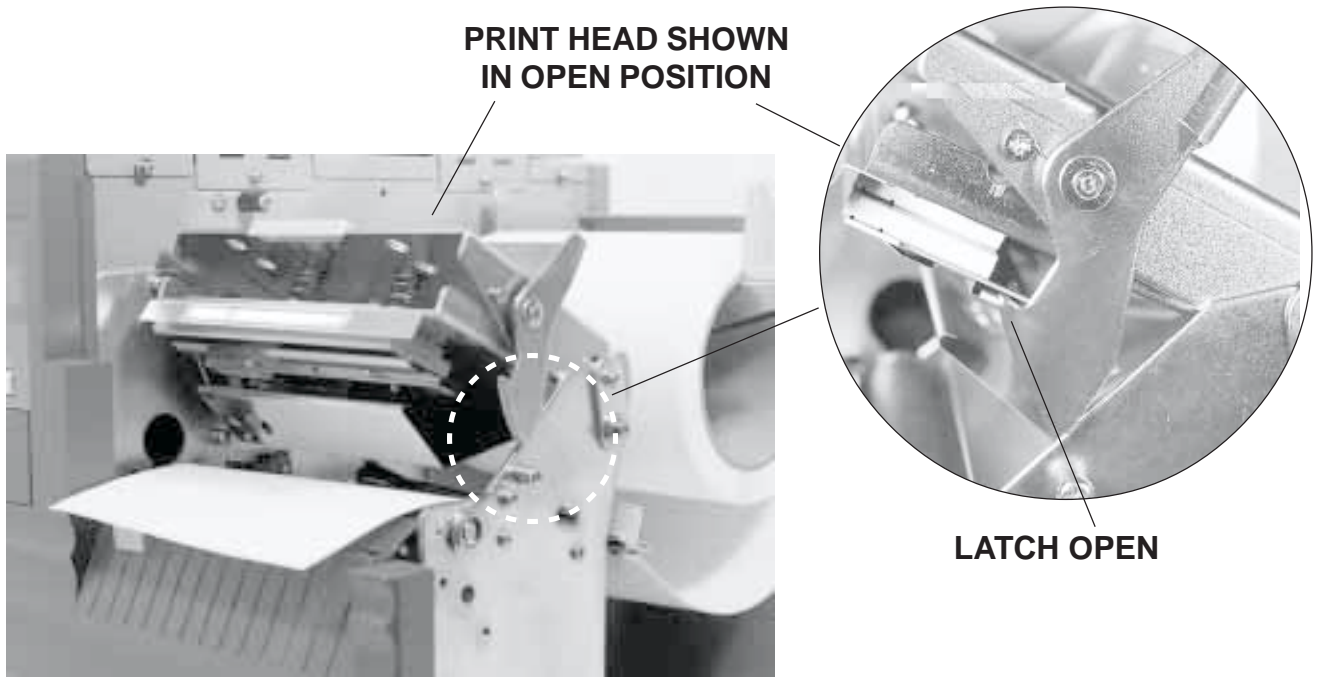

Loading Labels or Tags

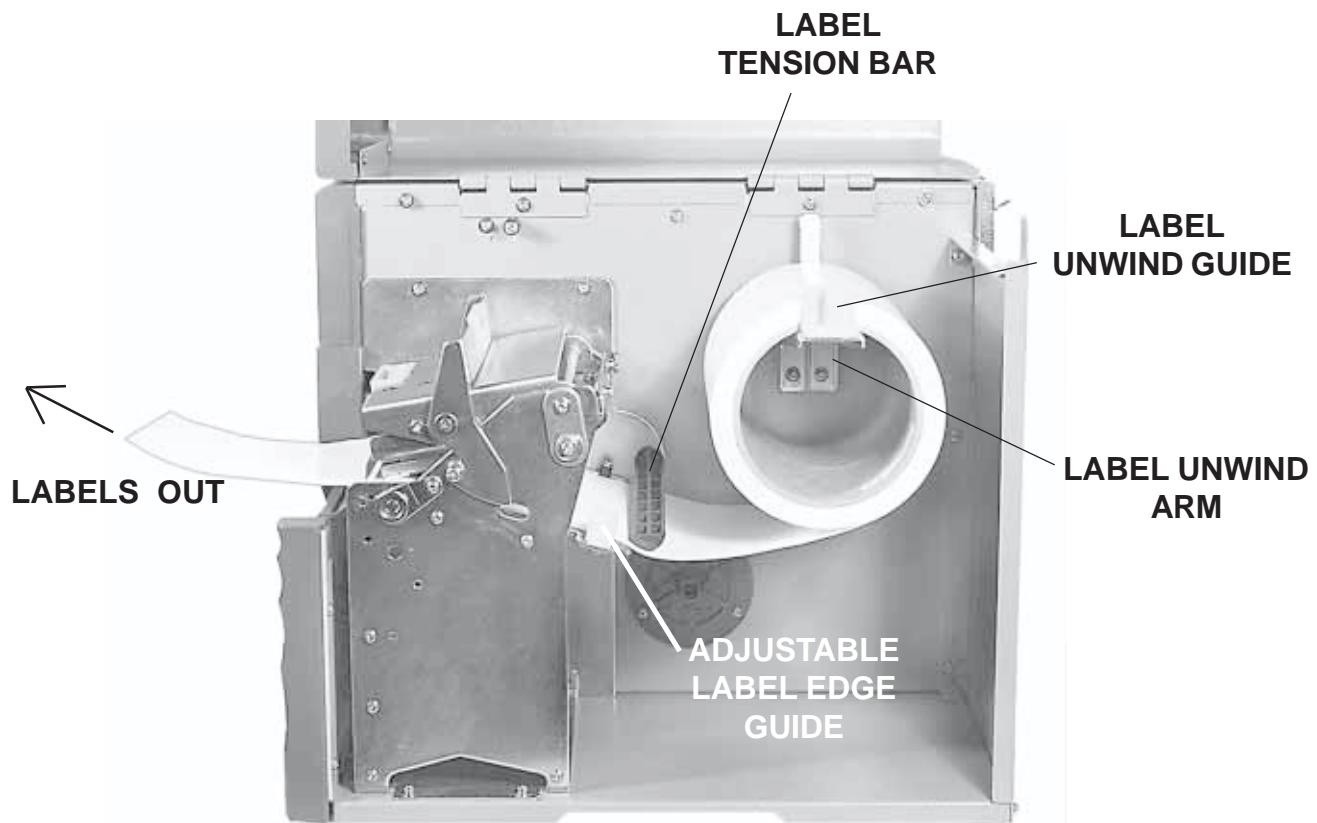

2.8 Dip Switch Settings

Two DIP switches (DSW2 & DSW3) are located underneath a flip-down cover on the operation panel. These switches can be used to set:

- Sensor Type
- Head Check Mode
- Hex Dump Mode
- Receive Buffer Size
- Protocol Code
- Compatible Mode
- Print Mode
- Pitch Sensor
- Backfeed
- Print Start Signal
- External Signal Type
- Repeat Signal



A third DIP Switch (DSW1) is located on a RS232 Serial Interface Card and is used to set transmit/receive parameters. This card is installed by inserting it through the slot in the back of the printer directly to the main PCB board. The switches can be set by either removing the card or by opening the left side panel.

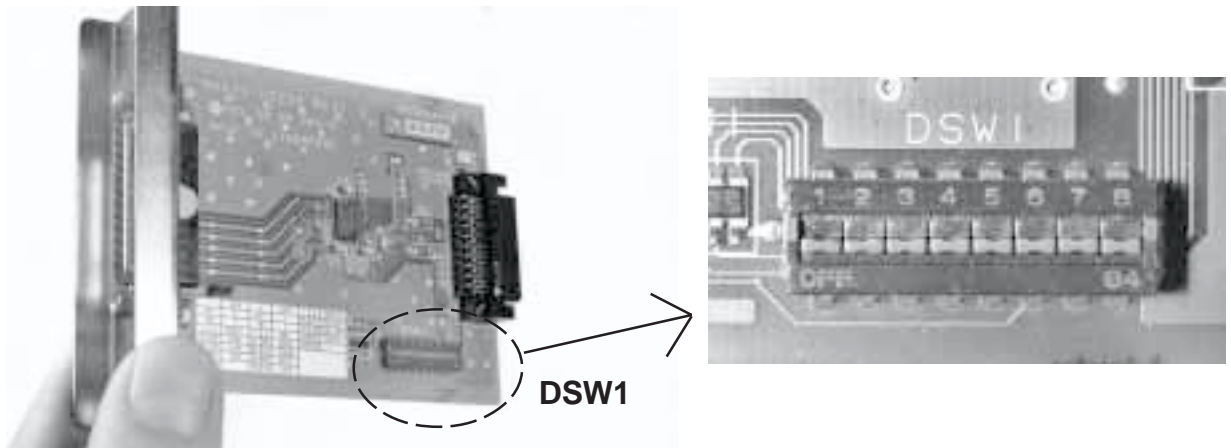

Each switch is an eight section "toggle" switch. The ON position is always to the top. To set the switches, first power the unit Off, then position the DIP switches. Finally after placing the switches in the desired positions, power the printer back on. The switch settings are read by the printer electronics during the power-up sequence. They will not become effect until the power is cycled

Dip Switch Settings

Printer Setup

Reserved for future use (DSW2-1)

DSW2-1
Reserved
Reserved

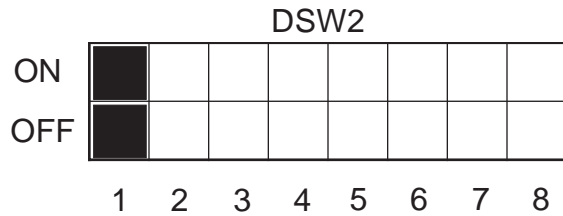

Sensor Type Selection (DSW2-2): Selects between the use of a label gap or a reflective Eye-Mark. See page 2-6 for the location of these sensors.

DSW2-2	SETTING
Off	Gap
On	Eye-Mark

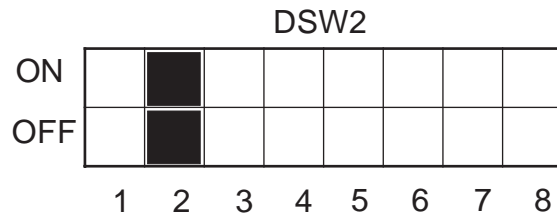

Head Check Selection (DSW2-3): When selected, the printer will check for head elements that are electrically malfunctioning.

DSW2-3	SETTING
Off	Disable
On	Enable

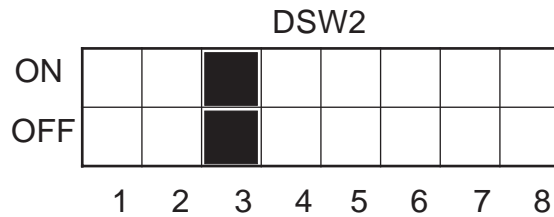

Hex Dump Selection (DSW2-4): Selects Hex Dump mode. (See page 2-38.)

DSW2-4	SETTING
Off	Disable
On	Enable

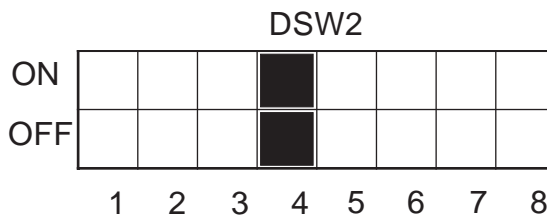

Receive Buffer Selection (DSW2-5): Selects the operating mode of the receive buffer. See Section 5: Interface Specifications for more information.

DSW2-5	SETTING
Off	Single Job
On	Multi-Job



Dip Switch Settings

Printer Setup

Reserved for future use (DSW2-6)

DSW2-6
Reserved
Reserved

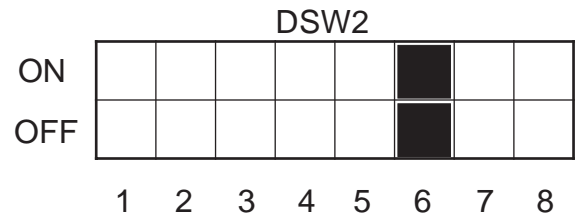

Protocol Code Selection (DSW2-7): Selects the command codes used for protocol control. Refer to Appendix E for more information.

DSW2-7	SETTING
Off	Standard
On	Non-Std.

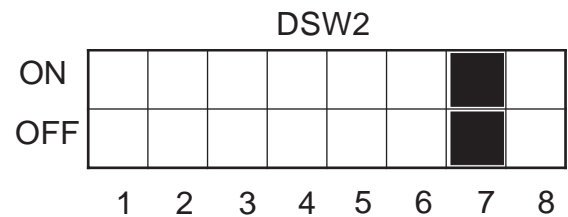

Emulation Mode (DSW2-8): For emulating features of the original M-5900 software.

DSW2-8	SETTING
Off	Normal Operation
On	Orig.M-5900

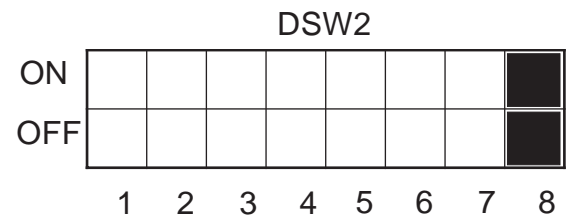

Mode Selection (DSW3-1 and DSW3-2): Selects the operating mode of the printer. Batch/Continuous disables the label taken (Dispense option) sensor.

DSW3-1	DSW3-2	SETTING
Off	Off	Batch/Continuous
Off	On	Tear Off
On	Off	Cutter
On	Off	Dispenser

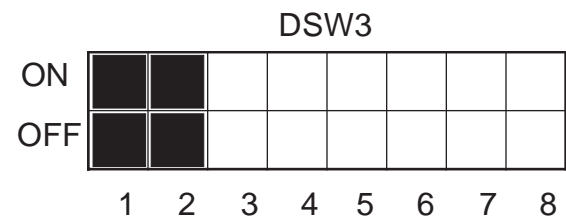

Dip Switch Settings

Printer Setup

Label Sensor Selection (DSW3-3): Enables or disables the Label Pitch sensor. If the sensor is enabled, it will detect the edge of the label and position it automatically. If it is disabled, the positioning must be under software control using Line Feed commands for continuous media printing.

DSW3-3	SETTING
Off	Enable
On	Disable

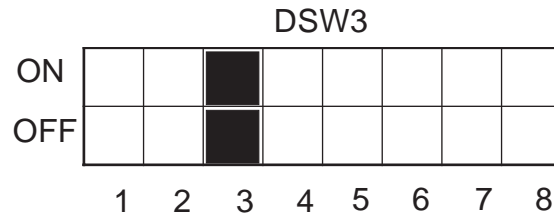

Back-Feed Selection (DSW3-4): When Back-Feed is enabled, the printer will position the label for dispensing/cutting and retract it before printing the next label. See page 2-40 for information on setting the amount of offset.

DSW3-4	SETTING
Off	Enable
On	Disable

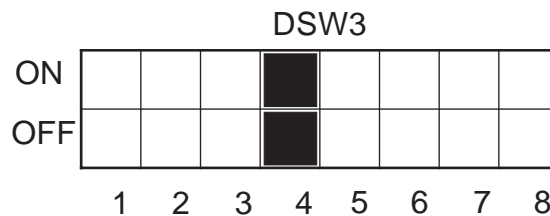

External Signal Interface

The EXT connector on the printer rear panel is intended for use with the external printer accessories such as label rewinders or applicators. The 14-pin Centronics type connector provides a choice of four different output signals along with various error conditions.

EXT Print Start Signal Selection (DSW3-5): Allows an external device to initiate a label print. See page 5-12 for a description of signal requirements.

DSW3-5	SETTING
Off	Disabled
On	Enabled



Note: This switch must be in the On position if an external device is used to control the printer via the EXT connector.

Dip Switch Settings

Printer Setup

External Signal Type Selection (DSW3-6 and DSW3-7): Selects the type of output signal. See page 5-13 for a description of signal types.

DSW3-6	DSW3-7	SETTING
Off	Off	Type 4
Off	On	Type 3
On	Off	Type 2
On	On	Type 1

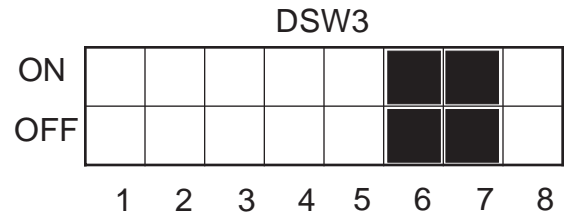

Repeat Print via External Sign (DSW3-8): Allows an external device to control the reprint of the label in the print buffer. See page 5-12 for a description of the signal requirements.

DSW3-8	SETTING
Off	Disabled
On	Enabled

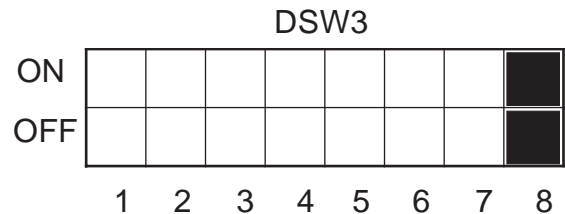

RS232 Transmit/Receive Setting (Located on RS232S Serial Interface Card)

Data Bit Selection (DSW1-1): This switch set the printer to receive either 7 or 8 bit data bits for each byte transmitted.

DSW1-1	SETTING
Off	8 data bits
On	7 data bits

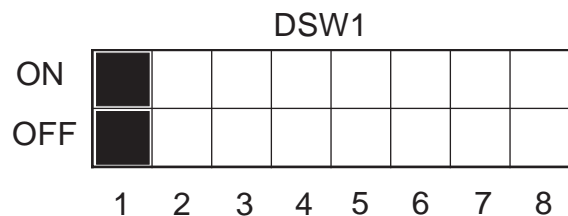

Parity Selection (DSW1-2 and DSW1-3): Selects the type of parity used for error detection.

DSW1-2	DSW1-3	SETTING
Off	Off	No Parity
Off	On	Even
On	Off	Odd
On	On	Not Used

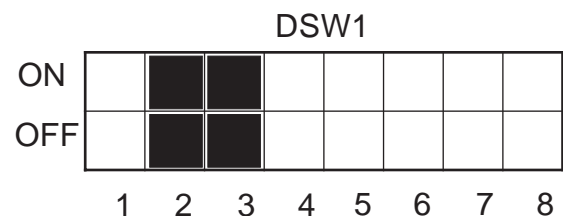

Dip Switch Settings

RS232 Transmit/Receive Setting

Stop Bit Selection (DSW1-4): Selects the number of stop bits to end each byte transmission.

DSW1-4	SETTING
Off	1 Stop Bit
On	2 Stop Bits



Baud Rate Selection (DSW1-5 and DSW1-6): Selects the data rate (bps) for the RS232 port.

DSW1-5	DSW1-6	SETTING
Off	Off	9600
Off	On	19200
On	Off	4800
On	On	2400

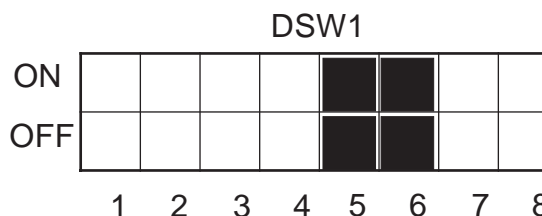

Protocol Selection (DSW1-7 and DSW1-8): Selects the flow control and status reporting protocols. See Section 5: Interface Specifications for more information.

DSW1-7	DSW1-8	SETTING
Off	Off	Rdy/Bsy
Off	On	Xon/Xoff
On	Off	Bi-Com
On	On	Status 2

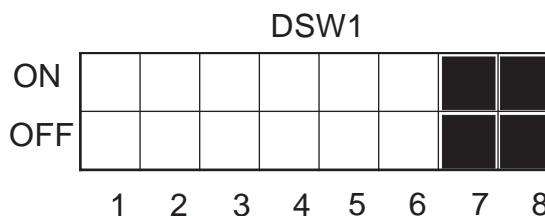

2.9 Default Settings

Switch Selections

All switches are placed in the Off position (default) for shipping. This will result in the following operating configuration:

Communications: ⁽¹⁾	8 data bits, no parity, 1 Stop bit, 9600 Baud
Protocol: ⁽¹⁾	Ready/Busy
Sensor:	Gap Sensor
Receive Buffer:	Single Job
Mode:	Batch Continuous
Label Sensor:	Sensor Used
Backfeed:	Disabled
External Signals:	Disabled

(1) Active only if an RS232 Interface Card is installed in the printer.

Software Default Settings - The printer stores any software settings upon receipt from the host and uses them until they are again changed by receipt of a command containing a new setting. These settings are stored in non-volatile RAM and are not affected by powering the printer off. The printer may be reset to use the default software settings by depressing the LINE and FEED keys simultaneously while powering the printer on. This will result in the following default configuration:

Parameter	Default Settings
Print Darkness	"3"
Print Speed	3 in. per sec.
Print Reference	Vertical = 0001, Horizontal = 0001
Zero	Slash
Auto On-Line	Enabled

Once the default operation is completed, a **DEFAULT SETTING COMPLETED** message will be displayed on the LCD panel and a single "beep" will be heard. The printer should be powered off while this message is being displayed. This saves the default settings in the EEPROM where they will be automatically loaded the next time the printer is powered on.

**DEFAULT SETTING
COMPLETED**

2.10 Printer Adjustments

The LCD Panel on the M-5900RV is used in conjunction with the **LINE** and **FEED** switches by the operator to manually enter printer configuration settings. Many of the settings can also be controlled via software commands and in the case of conflict between software and control panel settings, the printer will always use the last valid setting. If you load a label job that includes software settings and then enter a new setting via the Operation Panel, the manually set values will be used by the printer. If you set the values manually and then download a job with software settings, the software settings will be used.

POWER ON		
Normal/User Mode POWER	<i>ONLINE</i> <i>QTY:000000</i>	Page 2-21
User Test Print FEED+POWER	<i>USER TEST PRINT</i> <i>SMALL LARGE</i>	Page 2-36
Advanced Mode LINE+POWER	<i>ADVANCED MODE</i> <i>SETUP</i>	Page 2-24
Load SATO Default Settings LINE+FEED+POWER	<i>DEFAULT SETTING</i> <i>COMPLETED</i>	Page 2-19
User Download Defined Protocol Codes DSW2-7=ON +LINE+POWER	<i>USER DOWNLOAD</i>	Page E-2
Reset to SATO Default Protocol Codes DSW2-7=ON +LINE+FEED+POWER	<i>ALT. PROTOCOL</i> <i>DEFAULT COMPLETED</i>	Page E-2
Emulation Mode DSW2-8=ON+POWER	<i>ONLINE</i> <i>QTY:000000</i>	Page 2-15
Print Hex Dump Label POWER	PRINT BUFFER Hex Dump Label	Page 2-38
Print Hex Dump Label DSW2-4=ON+POWER	RECEIVE BUFFER Hex Dump Label	Page 2-38

Printer Adjustments

Normal Mode

When the printer is powered on, the readout should display the following message:

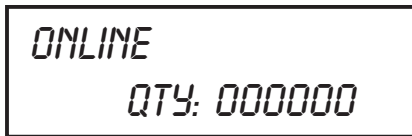

The LCD Panel will display the Online status on the top line of the display. The bottom line will contain the label quantity (QTY) status. The On Line message will be changed to OFF LINE whenever the printer is switched offline by depressing the LINE key. As soon as a print job is received, the QTY message will indicate the number of labels to be printed. As soon as the label job begins to print, the display will indicate the number of labels remaining in the print job that remain to be printed.

User Mode

To enter the USER mode, perform the following steps:

STEP	PROCEDURE
1.	The printer is first taken offline by pressing the LINE key once. The display will change to OFFLINE.
2.	Press the FEED and LINE keys simultaneously for more than one second. The printer now displays the first USER mode adjustment (Print Darkness).

Print Darkness Setting

There are five **Darkness** (or heat range) settings on the printer. The higher numbers represent darker settings. The current setting is indicated by a line under one of the range settings.

To change the setting perform the following steps:

STEP	PROCEDURE
1.	Use the LINE key to step the underlined cursor to the desired setting. 1 = Light 2 = Slightly Light 3 = Medium 4 = Slightly Dark 5 = Dark
2.	Once the correct setting is underlined, press the FEED key to accept the setting and advance to the next adjustment.

Note: The setting can be overridden by software. Finer adjustments can also be made using the PRINT potentiometer setting on the adjustment panel.

Printer Adjustments

Print Speed Adjustment

There are four **Speed** settings on the printer. The setting is listed on the bottom line of the display. The current setting is indicated by an underline under one of the speed settings. To change the setting:

STEP	PROCEDURE
1.	<p>Use the LINE key to step the underlined cursor to the desired speed setting.</p> <div style="display: flex; align-items: center;"> <div style="margin-right: 20px;"> <p>2 = 2 in/s (50mm/s)</p> <p>3 = 3 in/s (75mm/s)</p> <p>4 = 4 in/s (100mm/s)</p> <p>5 = 5 in/s (125mm/s)</p> </div> <div style="border: 1px solid black; padding: 5px; text-align: center;"> <p>PRINT SPEED</p> <p>2 <u>3</u> 4 5</p> </div> </div>
2.	<p>Once the correct setting is underlined, press the FEED key to accept the setting and advance to the next adjustment.</p> <p style="text-align: center;"><i>Note: The setting can be overridden by software.</i></p>

Pitch Offset and Direction

The label pitch is the distance from the leading edge, (the edge that comes out of the printer first) of a label and the leading edge of the printing. The leading edge position of the label can be adjusted relative to the print head +/- 49 mm in increments of 1 mm using the following procedure. Once the position is set, it can be adjusted +/- 3.75 mm using the PITCH potentiometer on the adjustment panel, (see page 2-40).

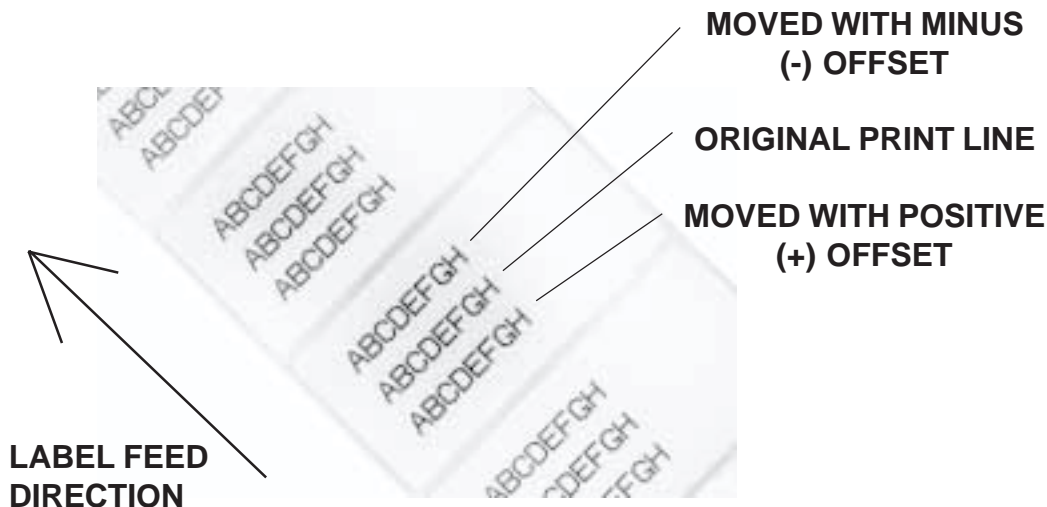

Printer Adjustments

Pitch Offset and Direction

To change the setting perform the following steps:

STEP	PROCEDURE
1.	<p>Use the LINE key to step the underlined cursor to either the positive (+) or the negative (-) selection. A positive selection increases the pitch offset direction while a negative selection decreases the pitch offset direction.</p> <div data-bbox="889 594 1333 730" style="border: 1px solid black; padding: 5px; text-align: center;"> <p>PITCH OFFSET ±00mm</p> </div>
2.	<p>Once the desired setting is underlined, press the FEED key to accept the (+/-) setting and advance to the first numerical position. Press the LINE key to set a value in the first position (0-4 only). Each time the line key is pressed, it will increment one step. Press the FEED key to advance to the second position to set a value. Press the line key repeatedly to advance to the desired value (0-9). Once the setting is correct, press the FEED key to accept the setting and advance to the Cancel Print job display.</p>
3.	<p>You may wish to check your settings by printing a test label after you have completed the adjustments to ensure that they are correct. See page 2-36 for instructions on how to print a test label.</p>

Printer Adjustments

Cancel Print Job

If the printer has a print job(s) loaded in memory, selecting YES will cause the job(s) to be cleared. The default selection is **NO**. Make sure that you want to cancel the print job before selecting **YES** as the job cannot be recovered and will have to be retransmitted to the printer.

To cancel the print, perform the following steps:



STEP	PROCEDURE
1.	Use the LINE key to step the underlined cursor to either No or Yes .
2.	Once the correct setting is underlined, press the FEED key to accept the setting and terminate the user mode of operation and return to the normal mode OFFLINE display. If you wish to change any of the settings, you must enter the user mode again by simultaneously pressing FEED and LINE keys for more than one second.

2.11 Advanced Mode Settings and Adjustments

Advanced mode is provided to make adjustments that require only occasional adjustments. Since they affect the basic operation of the printer, the procedure for entering this mode is designed to prevent someone from accidentally changing the settings.

To Enter Advanced Mode:

Power on the printer while pressing the **LINE** key. The printer will emit an audible signal and display Advanced Mode Setup on the LCD panel.



From the advanced mode display, the advanced settings are accessed in sequence by pressing the **FEED** key.

Advanced Mode

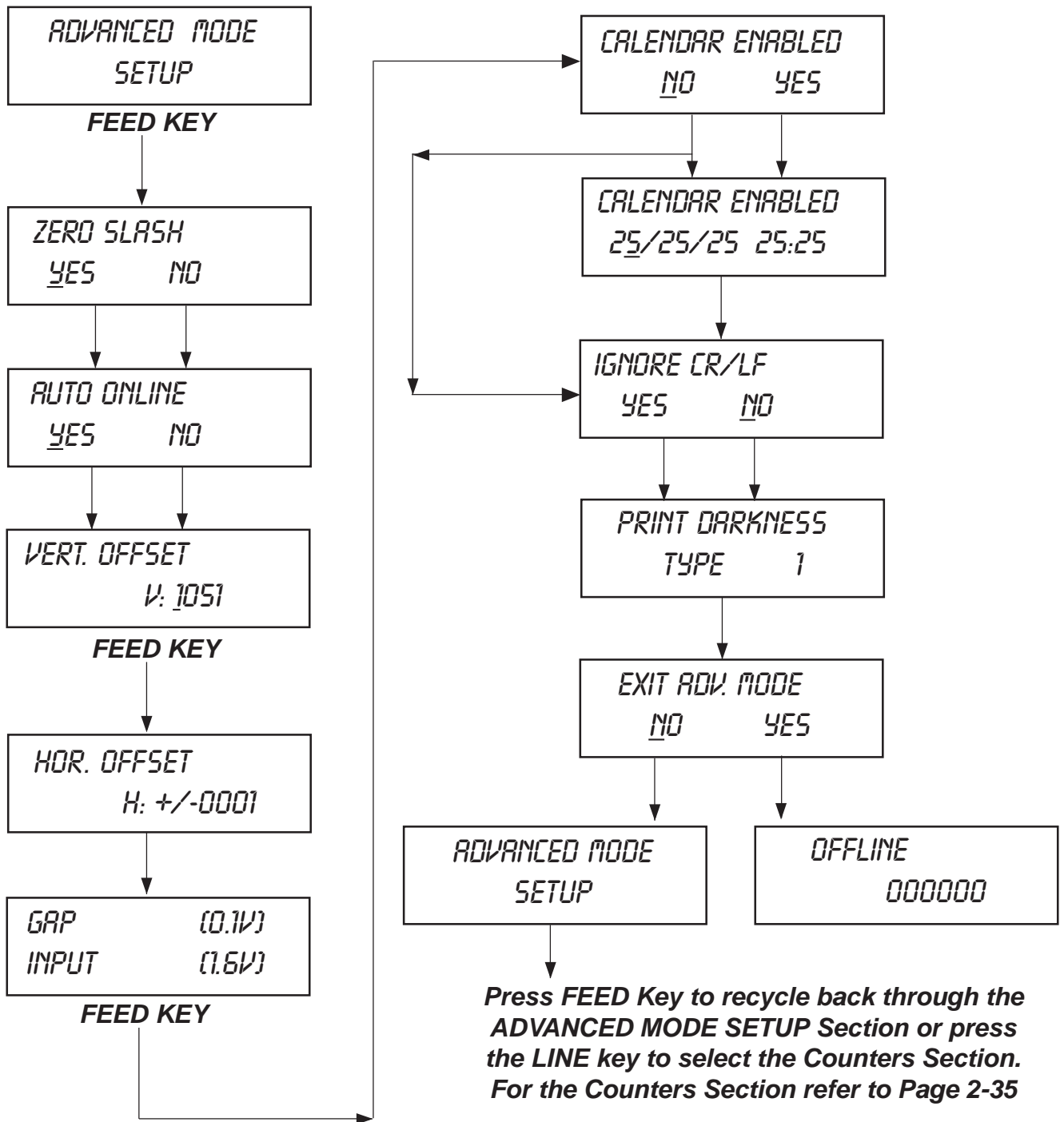

Refer to the pages 2-26 through 2-36 for details of each setting

Advanced Mode

Zero Slash Setting

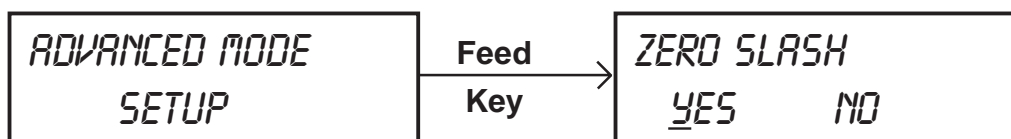

This setting determines if a zero is printed with a slash or without a slash. This setting can also be controlled via software commands. When YES is selected, the U, S, M, WB, WL, XU, XS, XM, XB, XL and vector fonts will have a slash through the center of the zero character.

To access this setting, perform the following steps:

STEP	PROCEDURE
1.	From the Advanced Mode Setup, press the FEED key to move to the Zero Slash display.
2.	Use the LINE key to step the underlined cursor to either YES or NO .
3.	Once the correct setting is underlined, press the FEED key to accept the setting and advance to the Auto Online display.

Auto Online Setting

This setting determines the mode in which the printer powers up. If the **YES** selection is made, the printer powers up in the **ONLINE** mode and is ready to print. If **NO** is selected, the printer powers up in the **OFFLINE** mode and must be manually placed in the ONLINE mode by pressing the **LINE** key before it is ready to print.

To access this setting perform the following steps:

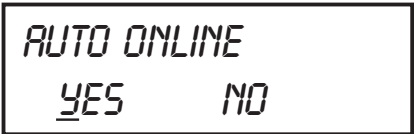
STEP	PROCEDURE
1.	Use the LINE key to step the underlined cursor to either YES or NO .
	
2.	Once the correct setting is underlined, press the FEED key to accept the setting and advance to the Vertical Offset display.

Advanced Mode

Vertical Offset Setting

Vertical Offset is the distance down from the leading edge, (the edge of the label that comes out of the printer first) to the first vertical print position. It is always a positive setting since making it negative would move it up and off the printable label. This setting changes the base reference point for all subsequent label jobs. It's effect is identical to the **<ESC>** A3 Base Reference point command. Since the printer moves the label in discrete steps equal to the size of the print dot, the units of measure for Vertical Offset distance is dots. The maximum value that can be set is 1424 (2848 in Expanded mode). Each dot is .0049 inches (.125mm)

Note: This setting can be overridden by the Base Reference Point Command. It is recommended that you relocate printing in your software as adjustments made here will affect all of you label formats.

To access this setting perform the following steps:

STEP	PROCEDURE
1.	Use the LINE key to step to the desired setting. The display will increment one step each time the LINE key is pressed. Press the FEED key to advance to each subsequent digit.
	
2.	Once the setting is correct, press the FEED key to accept the setting and advance the display to the Horizontal Direction display.



Advanced Mode

Horizontal Offset and Direction Setting

Horizontal Offset is the distance that the label image is shifted either to the right or left on the label. The image is shifted to the left (towards the inside edge of the label) for a positive setting and is shifted to the right (towards the outside edge of the label) for a negative setting. This setting changes the base reference point for all subsequent label jobs. It's effect is identical to the **<ESC>** A3 Base Reference point command. Since the printer can only print in discrete steps equal to the size of the print dot, the units of measure for the Horizontal Offset distance is dots.

Note: This setting can be overridden by the Base Reference Point Command. It is recommended that you relocate printing in your software as adjustments made here will affect all of your label formats.

To access this setting perform the following steps:

STEP	PROCEDURE
1.	Use the LINE key to step the underline to either the positive (+) or negative (-) selection. A positive selection increases (moves) the horizontal reference point for the label to the right edge of the label, towards the outside, while a negative selection moves the horizontal reference point for the label to the left, towards the inside of the printer.
	
2.	Once the setting is underlined, press the FEED key to accept the setting and advance the display to the Horizontal Offset adjustment.
3.	Use the LINE key to step the counter to the desired setting. The display will increment one step each time the LINE key is pressed. Press the FEED key to advance to each subsequent digit. The horizontal direction set in the previous step will be displayed in front of the Offset setting.
4.	Once the setting is correct, press the FEED key to accept the setting and advance to the Sensor Threshold display.

Advanced Mode

Printable Area

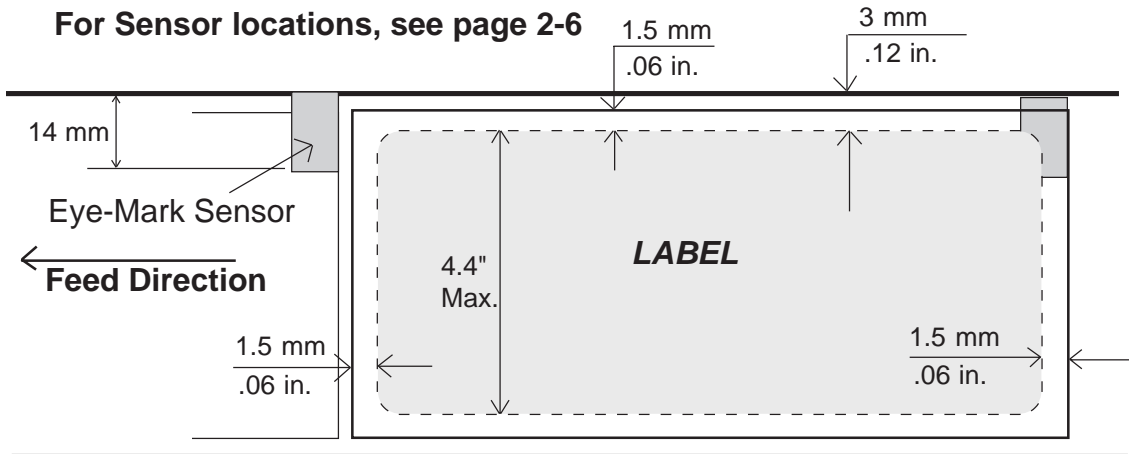

Eye-Mark

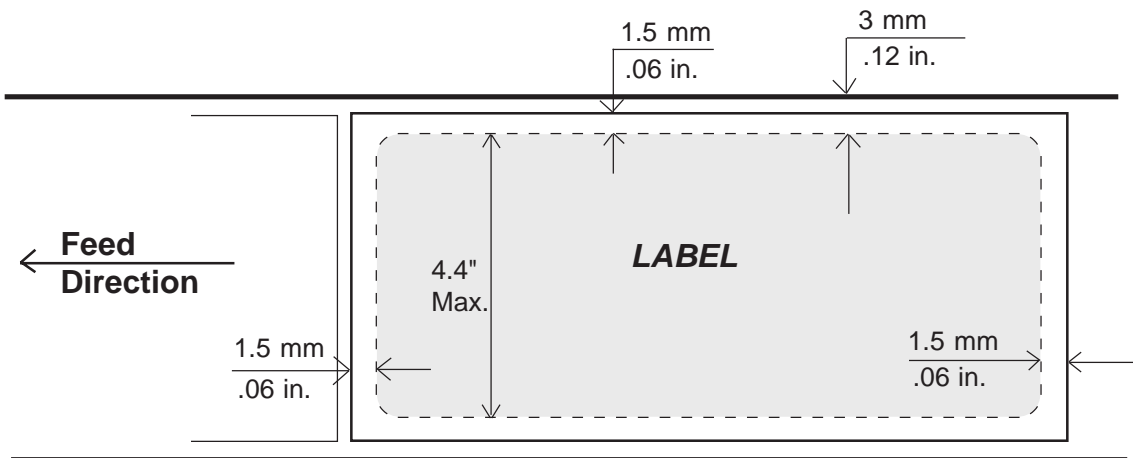

Gap

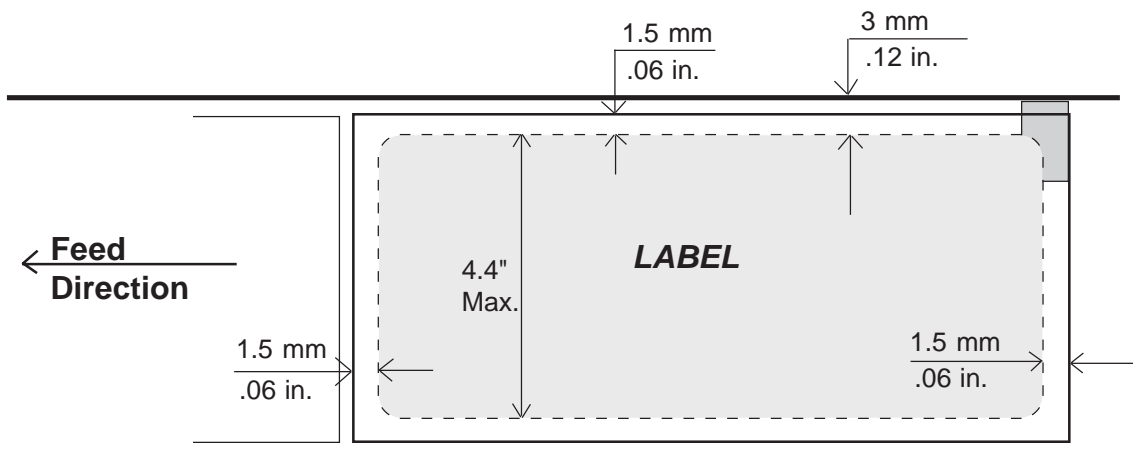

Tag

Advanced Mode

Sensor Threshold Level

The M-5900RV printer determines the location of the leading edge of the label by measuring the difference between light levels when it sees either a label edge or a black “Eye-Mark”. This adjustment allows you to manually set the threshold voltage level between the maximum and minimum light levels. DIP switch DSW2-2 selects the sensor type. If **DSW2-2** is in the **OFF** position, the setting will be for a See-Thru (or Gap) sensor and the LCD will display “**GAP**” on the top line along with the current setting. If **DSW2-2** is in the **ON** position, the LCD will display “Eye” on the top line with its current setting. If the value entered for the bottom line setting is “0.0V”, then the printer will automatically calculate the setting when the first label is fed after the printer is powered on or the head is closed. There are some instances where the automatically calculated value must be adjusted to ensure reliable label feeding, such as when the backing opacity or the reflectance of the “Eye-Mark” varies significantly within a roll of labels or between label rolls. In these instances the value should be set using the following procedures.

<i>GAP</i>	<i>[X.XV]</i>
<i>INPUT</i>	<i>[X.XV]</i>

GAP SENSOR: When setting the “gap” threshold, the voltage shown on the top line of the display must be measured with nothing but the backing paper in the sensor and then again with a label still attached to the backing. The formula to be used for setting the threshold is:

$$(\text{High Voltage Level} + \text{Low Voltage Level}) \times 0.5 = \text{Input Value}$$

Perform the steps on the following page:

Advanced Mode**GAP SENSOR:**

Perform these steps:

STEP	PROCEDURE				
1.	<p>Insert a label still attached to the backing into the sensor and close the head. Record the voltage shown on the top line of the LCD panel. This line should have the message "GAP" on the top line (DIP switch DSW2-2 = OFF). Make sure the label is all the way under the sensor and the See through Sensor is aligned over your label.</p>				
2.	<p>Stip the label from the backing and insert the backing strip under the sensor and close the head. Record the voltage shown on the top line of the LCD panel. The voltage ranges measured should be within the following ranges:</p> <table border="1" data-bbox="727 737 1409 884"> <thead> <tr> <th data-bbox="727 737 1052 810">Backing with Label</th> <th data-bbox="1052 737 1409 810">Label Backing Only</th> </tr> </thead> <tbody> <tr> <td data-bbox="727 810 1052 884">2.0V to 3.5V</td> <td data-bbox="1052 810 1409 884">1.0V or less</td> </tr> </tbody> </table> <p>If the measured values are outside this range, you may have trouble finding a value that will work properly under all conditions. If this is the case, a higher quality label may be needed to get adequate performance.</p>	Backing with Label	Label Backing Only	2.0V to 3.5V	1.0V or less
Backing with Label	Label Backing Only				
2.0V to 3.5V	1.0V or less				
3.	<p>Calculate the input point voltage using the formula shown on page 30.</p>				
4.	<p>Use the LINE key to step the counter to the desired value. The display will increment one step for each time the LINE key is pressed. If the LINE key is held down for more than two seconds, it will automatically go into the fast scroll mode. The reading will advance to a setting of 4.9 (the maximum voltage) after which it will automatically wrap and start at 0.0" again. If a value of 0.0" is set, the printer will automatically set the level half way between the two measured voltages each time the printer is powered on with labels loaded.</p>				
5.	<p>Repeat this procedure using values slightly higher of lower until the optimum performance is obtained. If you cannot find a setting between the high and low readings that gives adequate performance, then the label stock has too much variation in its opacity and a better quality stock should be used.</p>				
6.	<p>Once the setting is correct, press the FEED key to accept the setting.</p>				

Advanced Mode

Sensor Threshold Level (Cont)

"Eye-Mark" (Reflective) Sensor: When setting the "Eye-Mark" threshold, the voltage must be measured with nothing but the label over the sensor and then again with the printed "Eye-Mark" over the sensor. The formula for this is:

$$(High\ Voltage\ Level + Low\ Voltage\ Level) \times 0.5 = Input\ Value$$

To access this setting, perform the following steps:

STEP	PROCEDURE				
1.	Insert a label into the sensor and close the Label Hold-Down. Make sure the printed "Eye" is not over the sensor. Record the voltage shown on the top line of the LCD panel. This line should have the message "Eye" on the top line (DIP switch DSW2-2 =ON).				
2.	Now pull the label forward until the "Eye-mark" is positioned over the sensor (the voltage reading should be at its highest point). Record the voltage shown on the top line of the LCD panel. The voltage ranges measured should be within the following ranges: <table border="1" data-bbox="669 890 1341 1037" style="margin-left: auto; margin-right: auto;"> <thead> <tr> <th data-bbox="669 890 1013 961">Label Only</th> <th data-bbox="1013 890 1341 961">Eye Mark</th> </tr> </thead> <tbody> <tr> <td data-bbox="669 961 1013 1037">1.0V or less</td> <td data-bbox="1013 961 1341 1037">2.5V to 3.5V</td> </tr> </tbody> </table>	Label Only	Eye Mark	1.0V or less	2.5V to 3.5V
Label Only	Eye Mark				
1.0V or less	2.5V to 3.5V				
3.	Calculate the input point voltage using the formula shown at the beginning of this page.				
4.	Use the LINE key to step the counter to the desired setting. The display will increment one step for each time the LINE key is pressed. If the LINE key is held down for more than two seconds, it will automatically go into the fast scroll mode. The reading will advance to a setting of 4.9 (the maximum voltage) after which it will automatically wrap and start at 0.0" again. If a value of 0.0" is set, the printer will automatically set the level each time the printer is powered on with labels loaded or the head is closed.				
5.	Repeat this procedure using values slightly higher or lower until the optimum performance is obtained. If you cannot find a setting that will give you adequate performance, then the label stock or printed "Eye-Mark" too much variation in its reflectance and a better quality stock should be used.				
6.	Once the setting is correct, press the FEED key to accept the setting and advance to the Calendar Set display.				

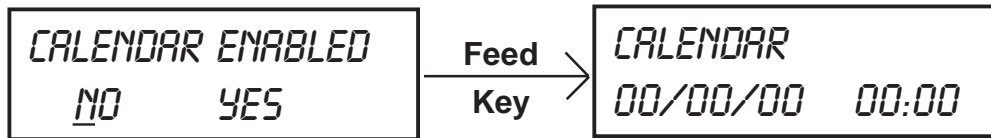
Advanced Mode**Calendar Set**

STEP	PROCEDURE
1.	Year: The first display shown will have the two digit year selection underlined. Press the LINE key to scroll through the dates. The year number will increase by one value each time the LINE key is pressed.
2.	Month: After you have set the correct year, press the FEED key to advance the underline cursor to the two digit Month position. Press the LINE key to scroll through the numbers corresponding to the month. The month number will increase by one value each time the LINE key is pressed.
3.	Day: After you have set the correct month, press the FEED key to advance the underline cursor to the two digit Day position. Press the LINE key to scroll through the numbers corresponding to the date. The date number will increase by one value each time the LINE key is pressed.
4.	Hour: After you have set the correct date, press the FEED key to advance the underline cursor to the two digit Hour position. Press the LINE key to scroll through the numbers corresponding to the hour (using a 24 hour clock). The hour number will increase by one value each time the LINE key is pressed.
5.	Minute: After you have set the correct hour, press the FEED key to advance the underline cursor to the two digit minute position. Press the LINE key to scroll through the numbers corresponding to the minute. The minute number will increase by one value each time the LINE key is pressed.
6.	After you have set the calendar, press the FEED key to accept the setting and advance to the next display.

Advanced Mode

Ignore Carriage Return/Line Feed

This setting is an entry provided to ignore a Carriage Return or Line Feed command in the data stream.

STEP	PROCEDURE
1.	Use the LINE key to step the underline cursor to the desired setting.
	
2.	Once the desired setting is underlined, press the FEED key to accept the setting and advance to the next adjustment.

Print Darkness Setting

There are two Darkness (or heat range) settings. If you are printing large amounts of coverage on each label you will want to choose TYPE 2 to prevent head saturation or excessive heat buildup. The current setting is indicated by a line under one of the range settings. Refer to Page 2-40 for user mode darkness settings that work in conjunction with these two broad range settings.

STEP	PROCEDURE
1.	Use the LINE key to step the underline cursor to the desired setting.
	
2.	Once the desired setting is underlined, press the FEED key to accept the setting and advance to the next adjustment.

Exit Advanced Mode

To access this setting, perform the following steps:

STEP	PROCEDURE
1.	Use the LINE key to step the underline cursor to either NO or Yes .
2.	Once the desired setting is underlined, press the FEED key to accept the setting and advance to the next adjustment. If you selected Yes the display will advance to OFFLINE . If you selected NO you will continue in the Advanced Mode for access to the Advanced Mode Counters . Once the desired setting is underlined, press the FEED key.

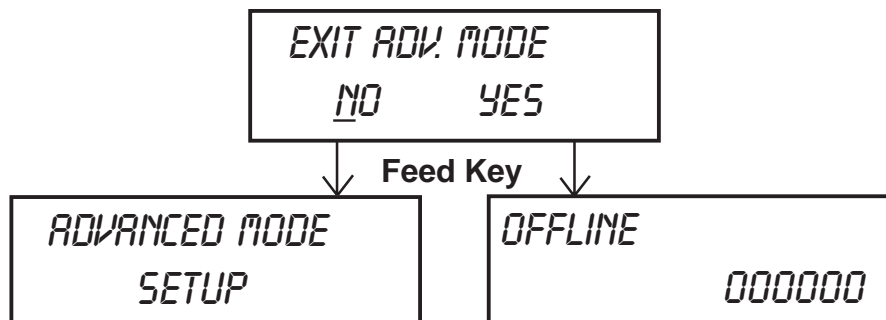

Advanced Mode

Advanced Mode Counters

The **Advanced Mode Counters** is provided for reading and clearing internal counters. These counters allow the user to keep track of the number of centimeters of label material that has passed through the printer, how many labels have been dispensed or how many labels have been cut. The **Advanced Mode Counters** display is entered by pressing the **LINE** key from the **Advanced Mode Setup**; then press the **FEED** key to advance through the counters.

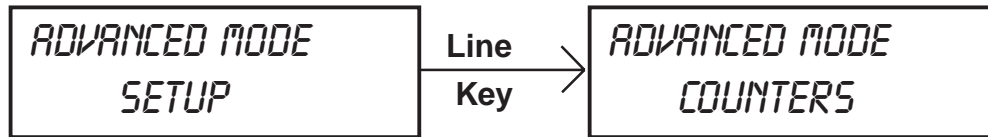

The Counters display allows you to select the counter to be viewed or cleared.

STEP	PROCEDURE
1.	<p>Press the FEED key to advance through the Counters display.</p> <div data-bbox="467 829 878 961" style="border: 1px solid black; padding: 5px; margin: 10px 0;"> <p style="text-align: center;">COUNTERS HD DSP CUT LIFE</p> </div> <p>HD: Head Counter DSP: Dispense Counter CUT: Cutter Counter LIFE: Life Counter</p>
2.	<p>Use the LINE key to step the underline cursor to the counter to be reset or displayed; the Head counter (HD), Dispenser (DSP) counter, CUT (Cutter) counter, or the LIFE counter.</p>
3.	<p>Once the desired setting is underlined, press the FEED key to display the values stored for that particular counter.</p> <div data-bbox="391 1472 1495 1717" style="border: 1px solid black; padding: 10px; margin: 10px 0;"> <p style="text-align: center;">HEAD COUNTER 0.0 CUT COUNTER 0.0 LIFE COUNTER 0.0</p> </div>

Printing Test Labels

Print Size

STEP	PROCEDURE
3.	<p>If SMALL is underlined, the Print Size message will be displayed. You must enter the size of the label. The minimum label size that can be selected is 4 cm (1.6”) and the maximum size is 10 cm (3.9”). Press the FEED key and then press the LINE key to increment the setting by 1 cm each time the key is pressed. Once the maximum size is reached, the display will wrap around and start incrementing at 4 cm again. Once the correct label width is selected, press the FEED key to initiate the print.</p> <div data-bbox="673 651 1144 798" style="border: 1px solid black; padding: 10px; text-align: center;"> <p>PRINT SIZE 04cm</p> </div>
4.	<p>If you wish to pause the printer after it starts to print a test label, press the FEED key. Press the FEED key again to resume the test label printing. To stop the test label print, pause the printer and then turn power off.</p>

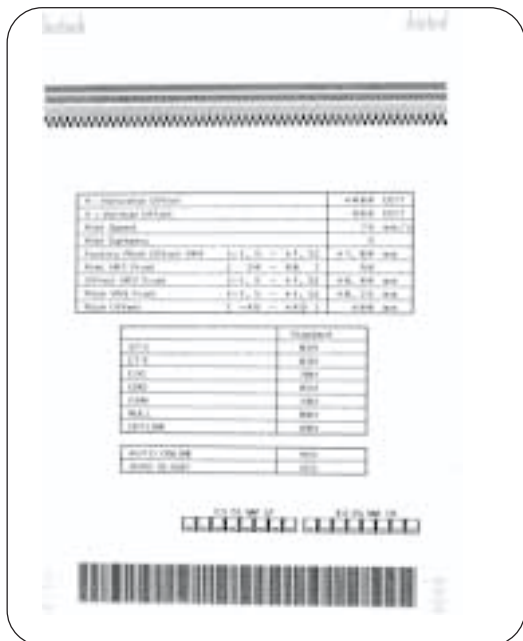

LARGE LABEL

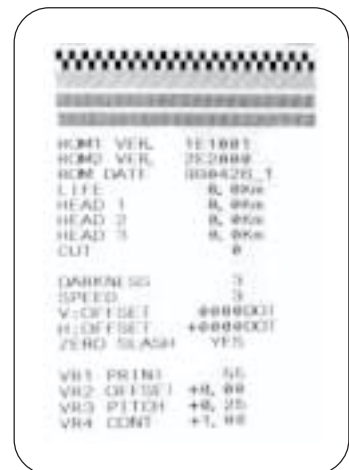

SMALL LABEL

2-13 Hex Dump Diagnostic Labels

In addition to the Printing Test Labels, the printer contents of the receive and print buffers can be examined using the Hex Dump Test Labels.

Print Buffer Hex Dump

The contents of the Print Buffer can be examined using the **Hex Dump** mode. The label numbers each line of data received in the left-hand column, the data in hexadecimal format in the center columns followed by the same data in ASCII format in the right-hand column.

STEP	PROCEDURE
1.	Turn the printer ON.
2.	Create and print a label.
3.	Place the printer in the Off-Line mode by pressing the LINE key.
4.	Place DSW2-4 in the ON position.
5.	Press the LINE key to place the printer back in the On-Line status.
6.	Press the FEED key.
7.	A label should be printed containing the contents of the print buffer in hexadecimal format.
8.	Return DSW2-4 to the OFF position.
9.	Turn the printer OFF and then back ON to place it back in the normal print mode.

Receive Buffer Hex Dump

The data that is being received by the printer (before it is placed in the Print Buffer) can be examined by using the Hex Dump Mode. The label numbers each line of data received in the left-hand column, the data in hexadecimal format in the center columns followed by the same data in ASCII format in the right-hand column.

STEP	PROCEDURE
1.	Turn the printer OFF.
2.	Place DSW2-4 in the ON position.
3.	Turn the printer ON.
4.	Transmit the data to the printer.
5.	The data received is printed out on a label in hexadecimal format.
6.	Return DSW2-4 to the OFF position.
7.	Turn the printer OFF and then back ON to place it back in the normal print mode.

Hex Dump Diagnostic Labels

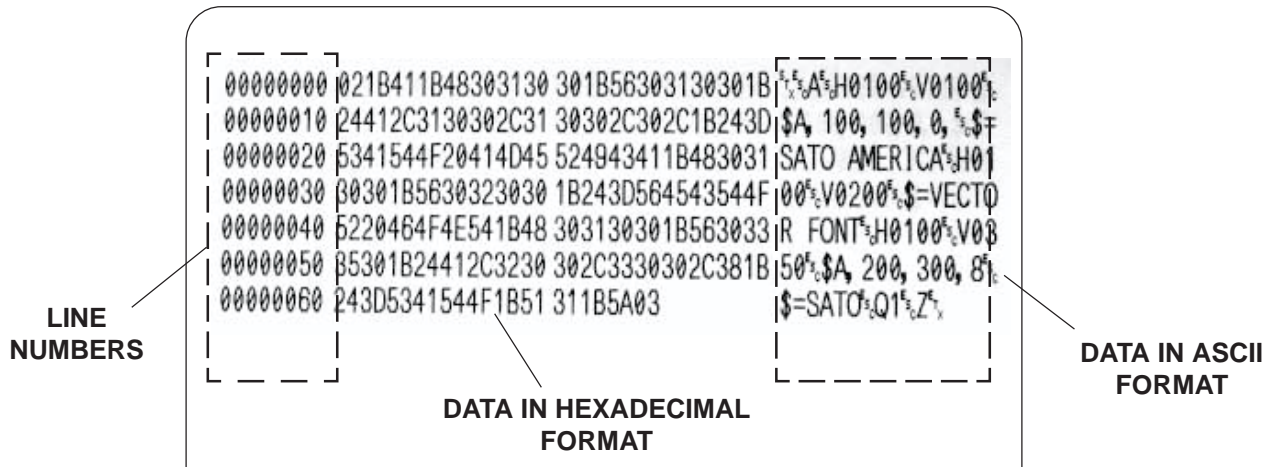

PRINT BUFFER HEX LABEL

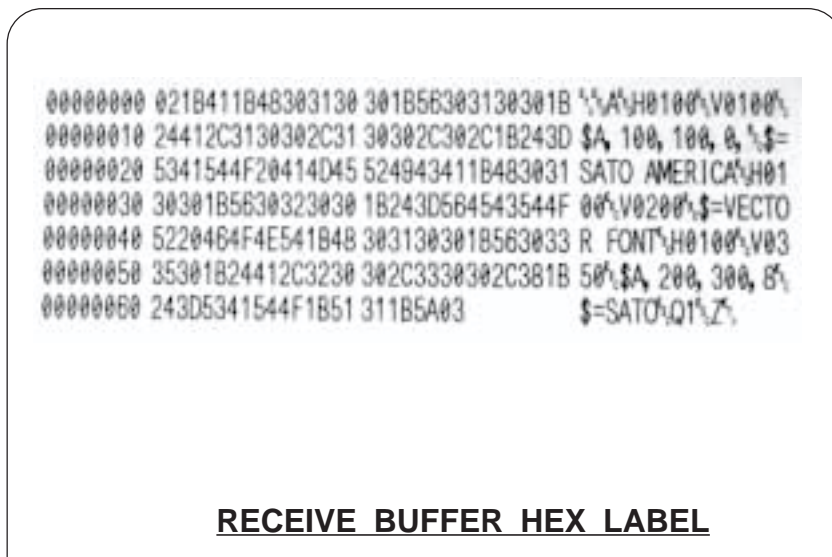

RECEIVE BUFFER HEX LABEL

2.14 Potentiometer Adjustments

Three potentiometers are located underneath a snap-on cover on the front panel. These are used to fine tune your printer as follows:

- **Print** Potentiometer to adjust print darkness/lightness of your print output.
- **Offset** Potentiometer to adjust amount of back/forward feed for dispenser/cutter/tear-off bar position (+/- 3.75 mm).
- **Pitch** Potentiometer to adjust home position of the label (+/- 3.75 mm). Affects stop position of label feed, print position and dispense position.

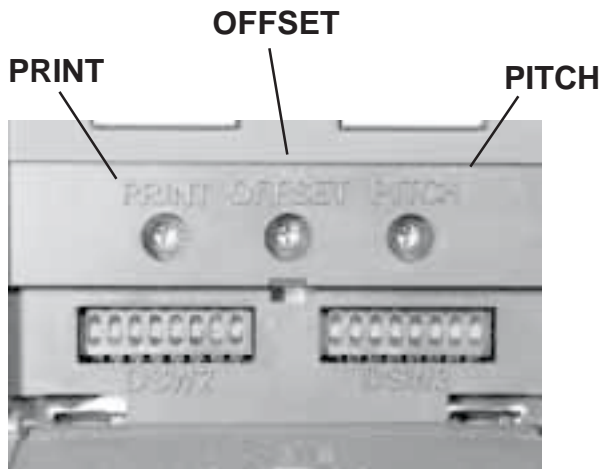

Print

This potentiometer is used to adjust the darkness/lightness of your printer output. Slowly turn the potentiometer counterclockwise to lighten or clockwise to darken.

Offset

When the printer is in the dispenser mode, (dip switch setting, page 2-15) the Feed Offset is used to correctly position the label for dispensing/cutting. Once the correct Feed Offset is obtained, the printer will position the label for dispensing/cutting and then reposition the next label before printing.

The amount of backfeed is controlled by the **OFFSET** potentiometer on the front panel. When turned all the way clockwise, the amount of backfeed adjustment is +3.75 mm and -3.75 mm when it is turned all the way counterclockwise.

STEP	PROCEDURE
1.	Turn the printer on.
2.	Press the LINE key to place the printer Off line.
3.	Press the FEED key to feed out a blank label.
4.	Adjust the position using the OFFSET potentiometer on the front control panel and feed another label by depressing the FEED key.
5.	When the adjustment is correct, turn the printer off.

Potentiometer Adjustments

Pitch

After the pitch has been set, it is sometimes desirable to make minor adjustments. This can be done using the **PITCH** potentiometer on the front panel. This potentiometer is set at the factory so that it has a range of +/- 3.75 mm. The midpoint setting should have no effect on the pitch. Turning the potentiometer all the way clockwise should move the print position 3.75 mm up towards the top edge of the label. Turning it all the way counterclockwise should move the print position down 3.75 mm.

STEP	PROCEDURE
1.	While depressing the FEED key on the front panel turn the printer on.
2.	Refer to Page 2-36, "Printing Test Labels" and print a label, large or small.
3.	Adjust the PITCH potentiometer on the front panel until the first print position is at the desired location on the label. If the potentiometer does not have enough range, then you will must change the pitch setting using the front panel display.
4.	Press the FEED key to stop the printer. Adjusting the PITCH potentiometer will affect the stop position of the label and the cut/dispense/tear-off position.

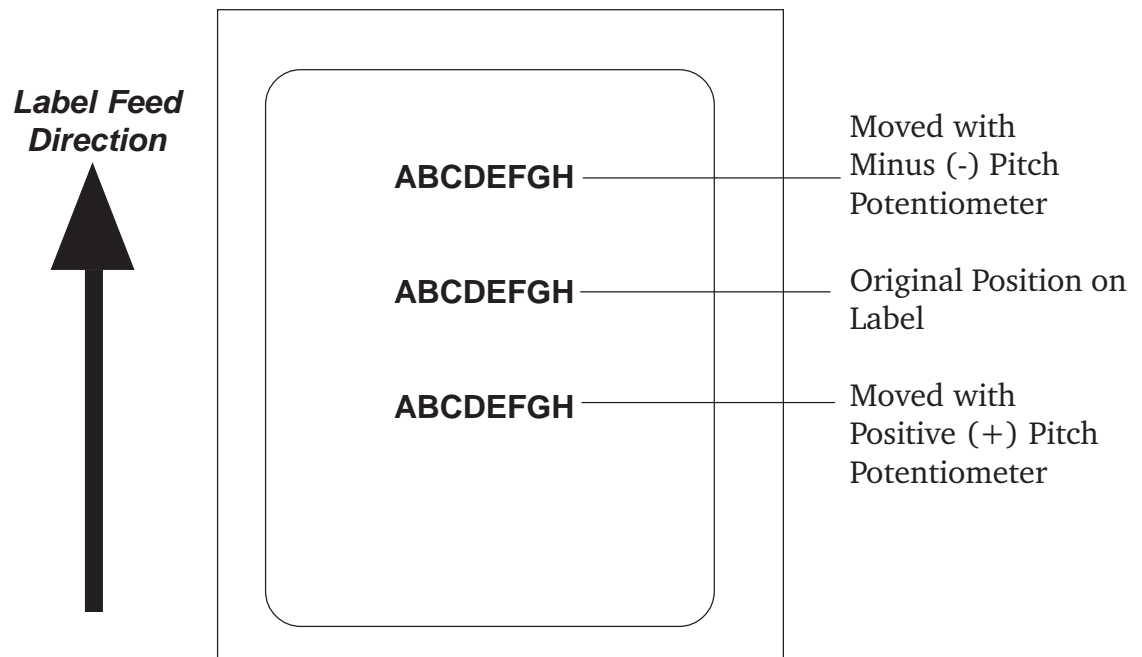



Adjustments and Maintenance

3.1 Introduction

The following information is presented in this section:

- Adjusting the Print Quality
- Cleaning the Print Head and Platen
- Replacing the Print Head

3.2 Adjusting the Print Quality

The M-5900RV printer is equipped with two different methods of adjusting the quality of the print; print darkness and speed. When adjusting the printer for optimum print quality, a bar code verifier system should be used. The human eye is a poor judge of the relative widths of the bars in a symbol, a characteristic that is extremely important for good bar code quality.

Darkness (Print)

This adjustment allows the user to control (within a specified range), the amount of power that is used to activate the individual print head elements. It is important to find a proper print darkness level based on your particular label and ribbon combination. The printed images should not be too light nor should the ink from the ribbon "bleed". The edges of each image should be crisp and well defined.

You can select a value from the Print Darkness range by using the front LCD panel or by downloading a setting using the Print Darkness software command. If you use the LCD panel there are five Darkness (or heat range) settings. See page 2-21 for method.

If you use the Print Darkness software command you can input a precise value of 1 to 5. See page 4-58, Programming Reference for method.

Once the value has been selected, the **PRINT** Potentiometer on the front panel can be used to make finer adjustments. See next page for method.

Print Potentiometer

If necessary, use the **PRINT** potentiometer on the operator panel to make fine adjustments for print darkness. It provides a continuous range of adjustment, allowing you to make precise changes. Use a small cross-point screwdriver, turning clockwise for darker prints and counterclockwise for lighter prints.

NOTE: The PRINT potentiometer adjustment will affect the darkness in all of the command code speed ranges, i.e., if the PRINT potentiometer is adjusted for lighter prints, the darkness will be lighter in all speed ranges selected by the command code.



Print Speed

The other method of controlling print quality is by controlling the speed at which the label is printed. This adjustment is made only on an individual label basis using either the Print Speed command code or the LCD display panel. For more details on this command, see Page 4-64 in Section 4: Programming Reference. Changing the print speed allows the user to control the amount of time allowed for print element cooling before the media is stepped to the next print position. It is especially critical when printing "ladder" bar codes (bar codes printed with the bars parallel to the print line). When printing a "ladder" bar code, it is important to allow the head to cool sufficiently before stepping to the next position. If it does not have sufficient time to cool, the bar will be "smeared" on the trailing edge.

You can select a value from the Print Speed adjustment range by using the front LCD panel or by downloading a setting using the Print Speed software command. If you use the LCD panel there are four settings. See page 2-22 for method.

If you use the Print Speed software command you can input a precise value of 1 to 5. See page 4-64, Programming Reference for method. The software command will override any setting entered using the LCD panel.

3.3 Cleaning the Print Head and Platen

Cleaning the M-5900RV print head and platen is a necessary maintenance procedure to ensure the best print quality and life expectancy of each item. This section explains the steps that should be taken to properly clean the print head and platen.

NOTE: Only solvent recommended by SATO should be used to periodically remove paper residue from the print head. Apply with a cotton swab using due care. Frequency of cleaning depends upon paper type and mechanical factors but should be done at least every two rolls of labels.

- Do not use abrasive materials in cleaning.
- Only clean when the print head has been de-energized and cooled to room ambient temperature to avoid thermal shock damage.
- Do not operate the machine for at least 15 minutes after cleaning to ensure the head is totally dry of any cleaning fluids.

Print Head

Supplies needed:

SATO SA070 Cleaning Kit (or equivalent)



STEP	PROCEDURE
1.	Turn OFF the Power Switch
2.	Raise the printer side door. Figs. Page 3-4
3.	Open the PRINT HEAD ASSEMBLY by pulling forward on the bar atop the assembly (green lever guard marked "PULL"). Figs. Page 3-4
4.	Apply the SATO Thermal Print Head and Platen Cleaner to a cotton swab.
5.	With the dampened portion of the cotton swab, gently wipe along the entire length of the print head. (Note that the print head faces downward along the front edge of the assembly.) Figs. Page 3-4
6.	Check for any adhesive on the swab after cleaning.
7.	Repeat if necessary.
	<p>NOTE: The print head should be cleaned after every two rolls of printed labels. Cleaning will greatly improve the life of the print head.</p> <p>CAUTION: Note that the tear bar which is located directly in front of the print head, is very sharp. <u>Be extremely careful</u> around this tear bar when cleaning the print head.</p>

Cleaning the Print Head and Platen



**RAISE THE PRINTER
SIDE DOOR**

**OPEN THE PRINT
HEAD ASSEMBLY**

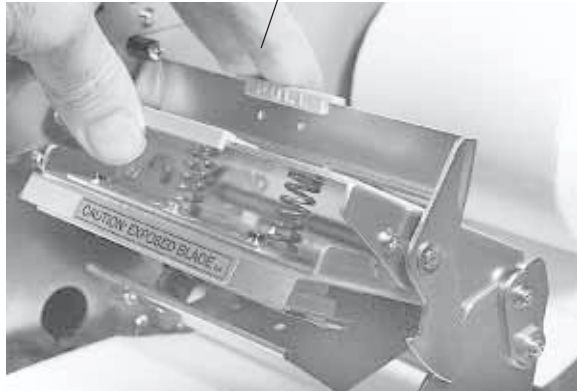

**Apply SATO Thermal Print
Head and Platen Cleaner to a
cotton swab and gently wipe
across the print head**

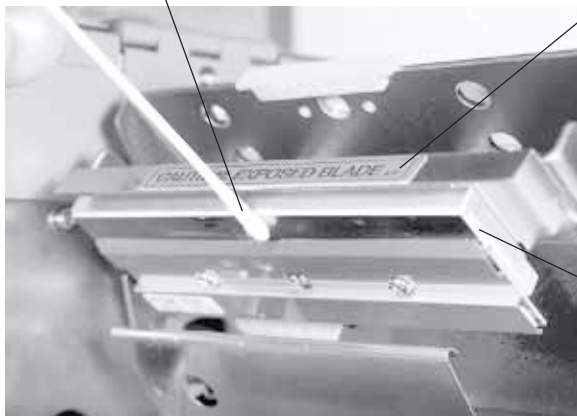

**CAUTION: Be extremely careful
around the tear bar which is
located directly in front of the
print head and is very sharp**

PRINT HEAD

Cleaning the Print Head and Platen

Platen

Supplies needed:

SATO SA070 Cleaning Kit (or equivalent)

STEP	PROCEDURE
1.	Turn OFF the Power Switch
2.	Raise the printer side door. Fig. Page 3-4
3.	Open the PRINT HEAD ASSEMBLY by pulling forward on the bar atop the assembly (green lever guard marked "PULL"). Fig. Page 3-4
4.	Apply the SATO Thermal Print Head and Platen Cleaner to one of the clean wipes or a cotton swab.
5.	With the dampened portion of the clean wipe or cotton swab, gently wipe along the entire length of the platen. Make sure to rotate the platen so as to clean its entire surface. (Note that the platen is the black rubber roller directly below the print head.) Fig. Page 3-5
6.	Repeat if necessary.

NOTE: The platen should be cleaned after every two rolls of printed labels. Cleaning will ensure proper label movement through the printer.

Apply SATO Thermal Print Head and Platen Cleaner to a clean wipe or cotton swab and gently wipe across the entire length of the platen, rotating to clean the entire surface

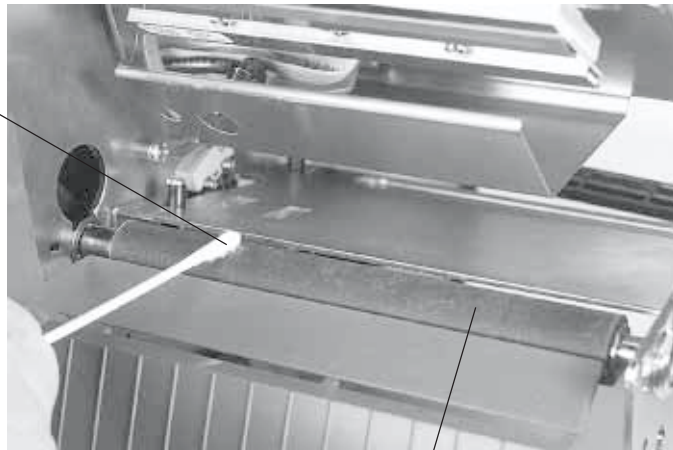

PLATEN

3.4 Replacing the Print Head

The print head on the M-5900RV is a user-replaceable item. This section explains how a defective print head can be easily removed and replaced. Contact your local SATO representative for information on obtaining a new print head.

NOTE: The print head contains a precision printing surface that must be carefully protected from mechanical damage. Extreme care must be exercised during handling and installing to prevent scratching, chipping, denting or otherwise damaging the exposed substrate surface, particularly in the resistor (printing element) area. A small clean piece of cardboard should be used to protect the substrate during installation if there is a possibility of accidental damage.

Supplies needed:

- Small Flathead Screwdriver
- Phillips Screwdriver

STEP	PROCEDURE
1.	Turn OFF the Power Switch
2.	Raise the printer side door. Figs. Page 3-7
3.	Leave the print head assembly closed initially.
4.	Remove the green plastic lever guard marked "PUSH" by gently prying the back edge with a small flat head screwdriver. Figs. Page 3-7
5.	Using the phillips screwdriver, remove only the middle set screw on top of the print head and carefully set it aside. Figs. Page 3-7
6.	Gently open the print head assembly by holding down on the front edge of the print head assembly while pulling forward on the green plastic lever guard marked "PULL". The print head and tear bar will separate from the rest of the assembly.

**Text Continued
on Page 3-8**

Replacing the Print Head



**RAISE THE
PRINTER SIDE
DOOR**

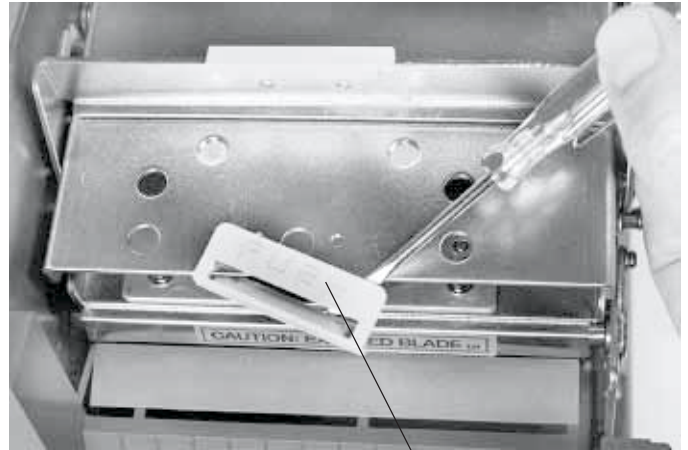

**REMOVE THE
GREEN PLASTIC
LEVER GUARD**

Hold down on the front edge of the print head assembly while pulling forward on plastic lever marked "PULL"



**REMOVE ONLY THE
MIDDLE SCREW**

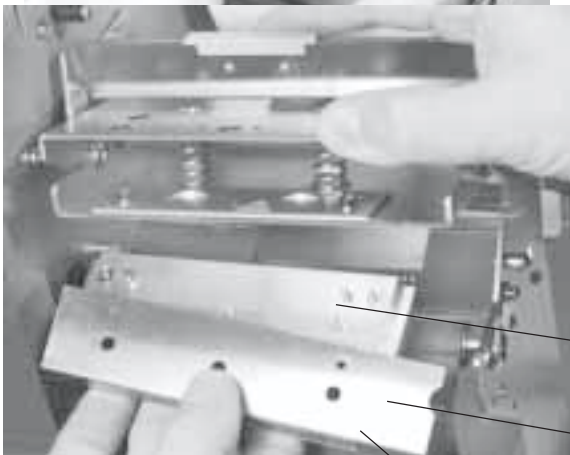
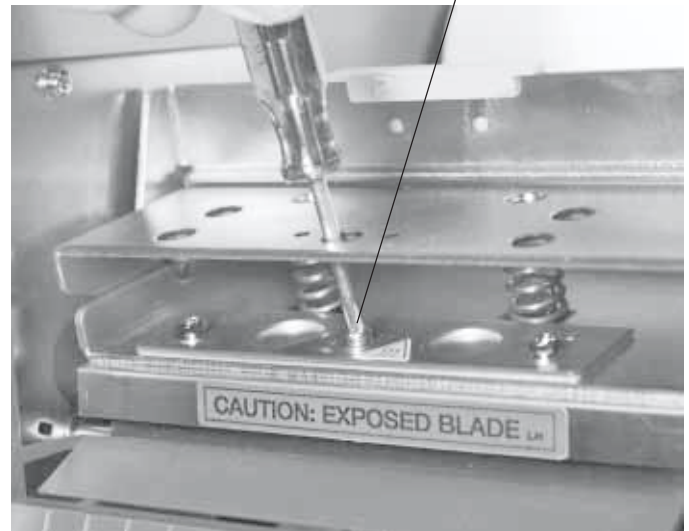

PRINT HEAD

TEAR BAR

**PRINT HEAD AND TEAR
BAR WILL SEPARATE**

Replacing the Print Head

STEP	PROCEDURE
7.	While holding the print head firmly from the sides, carefully disconnect the cable at the back of the print head. Set the damaged print head and tear bar aside. Fig. Page 3-8
8.	Carefully attach the new print head to the cable connector. CAUTION: This connector is keyed and should never be forced together incorrectly. Be careful not to scratch the printing surface



Programming Reference

4.1 Introduction

This section presents the commands that are used with the SATO Series printers to produce labels with logos, bar codes and alphanumeric data. All of the RISC commands use the same syntax. Some commands reference a physical point on the label using horizontal and vertical dot reference numbers. The allowable range for these references is dependent upon the particular printer to accommodate different print widths and resolutions.

The following information is presented in this section:

- The SATO Command Programming Language
- Protocol Control Codes Selection
- Using Basic
- The Print Area
- Command Codes

4.2 The SATO RISC Programming Language

A programming language for a printer is a familiar concept to most programmers. It is a group of commands that are designed to use the internal intelligence of the printer. The commands, which are referred to as RISC Command Codes, contain non-printable ASCII characters (such as <STX>, <ETX>, <ESC>) and printable characters. These commands must be assembled into an organized block of code to be sent as one data stream to the printer, which in turn interprets the command codes and generates the desired label output. The programmer is free to use any programming language available to send the desired data to the SATO RISC Series printer.

The command codes used by the SATO RISC Series Printers are based upon “Escape” (1B hexadecimal) sequences. Typically there are four types of command sequences:

<ESC>{Command}

These commands generally tell the printer to perform a specific action, like “clear the memory.”

<ESC>{Command} {Data}

Commands with this format tell the printer to perform a specific action which is dependent upon the following data, like “print X labels”, where the value for X is contained in the data.

<ESC>{Command}{Parameter}

These commands set the operational parameters of the printer, like “set the print speed to 3”.

<ESC>{Command}{Parameter}{Data}

Some commands can contain both Parameter and Data elements, such as “print a Code 39 symbol containing the data”.

4.3 Selecting Protocol Control Codes

Protocol codes are the special control characters that prepare the printer to receive instructions. For example, the <ESC> character tells the printer that a command code will follow and the <ENQ> character asks for the printer status.

There are two pre-defined different sets of Protocol Control codes to choose from. Each set is made up of six special characters. The Standard Protocol Control codes are non-printable characters, and the Non-Standard Protocol Control codes are printable characters. The Non-Standard set may be useful on host computers using protocol converters or in an application where non-printable ASCII characters cannot be sent from the host. This manual uses the Standard Protocol Control codes for all of the examples. Alternately, the user may define and download a set of custom Protocol Control Codes (See Appendix E).

The Protocol Control codes are selected by a DIP switch DSW2-7 on the front panel (see Section 2: Printer DIP Switch Settings, Page 2-13).

CONTROL CHARACTER	STANDARD DSW2-7 OFF	NON-STANDARD DSW2-7 ON	DESCRIPTION
STX	02 Hex	7B Hex = {	Start of Data
ETX	03 Hex	7D Hex = }	End of Data
ESC	1B Hex	5E Hex = ^	Command code to follow
~	7E Hex	7E Hex = ~	Cutter command
ENQ	05 Hex	40 Hex = @	Get printer status, Bi-Com mode
CAN	18 Hex	21 Hex = !	Cancel print job, Bi-Com mode
Off-Line	40 Hex	5D Hex =]	Take printer Off-Line

4.4 Using Basic

It may be useful to test your printer using a BASIC program on a PC. You may also write your actual production programs in BASIC. Whatever the reason, if you will be working in BASIC, some of the following hints may help you get started:

1. Set the WIDTH of the output device to 255 characters to avoid automatically sending <CR> and <LF> characters after every line. The command string should be continuous and uninterrupted by <CR> and /or <LF> commands. The examples given in this manual are printed on separate lines because they will not fit on one line and do not contain any <CR> and /or <LF> characters. If these characters are needed, they are explicitly noted by the inclusion of <CR> and <LF> notations.
2. If you are using the printer's RS232 interface, it is necessary to set the COM port on the PC such that CTS and DSR signals will be ignored. Send your OPEN "COM" statement in the following way:

```
OPEN "COM1:9600, E,8,1,CS,DS" AS#1
```

This sets the RS232 communication parameters of the host PC's COM1 port for 9600 baud, Even parity, 8 Data bits, 1 Stop bit and directing the port to ignore the **CTS** and **DSR** control signals.

3. You may want to minimize keystrokes and program size by assigning the <ESC> character to a string variable since this character is used quite often.

The following two examples in BASIC show a typical example using these hints. Both of these examples use the Standard Protocol codes.

Printing with the Parallel Port

5 REM Parallel Example:	Identifies the program as a parallel port print label. The "REM" prevents this data from being sent to the printer and displays it only on the screen.
10 E\$=CHR\$(27)	Sets the "E\$" string as an <ESC> character.
20 WIDTH "LPT1:",255	Sets the width of the output to 255 characters.
30 LPRINT E\$; "A";	Sends an "<ESC>A" command code to the LPT parallel port.

Printing with the Parallel Port

40 LPRINT E\$;"H400";E\$;"V100";E\$;"XL1SATO"; Sends the data "SATO" to be placed 400 dots horizontally and 100 dots vertically on the label and printed in the "XL" font.

50 LPRINT E\$;"Q1"; Instructs the printer to print one label.

60 LPRINT E\$;"Z"; Tells the printer that the last command has been sent. The printer can now create and print the job.

Printing with the RS232 Port:

5 REM RS232 Example Identifies the program as an RS232 port print label. The "REM" prevents this data from being sent to the printer and displays it only on the screen.

10 E\$=CHR\$(27) Sets the "E\$" string as an <ESC> character.

20 OPEN "COM1:9600,N,8,1,CS,DS" AS #1; Opens the COM1 port for output and sets the parameters as 9600 baud, No parity, 8 Data bits, 1 Stop bit and instructs the port to ignore the CTS and DSR control signals.

30 PRINT #1,CHR\$(2); Sends an <STX> (ASCII Code a decimal "2") to the printer instructing it to prepare to receive a message.

40 PRINT #1,E\$;"A"; Sends an "<ESC>A" command code to Print Port #1 opened by statement 20 above.

Printing with the RS232 Port:

50 PRINT #1, E\$;"H400",E\$;"V100";E\$;"XL1SATO";	Sends the data "SATO" to be placed 400 dots horizontally and 100 dots vertically on the label and printed in the "XL" autosmoothed font.
60 PRINT #1, E\$;"Q1";	Instructs the printer to print a quantity of one label.
70 PRINT #1, E\$;"Z";	Tells the printer that the last command has been sent. The printer can now create and print the job.
80 PRINT #1, CHR\$ (3);	Sends an "<ETX> (ASCII Code decimal "3") to the printer telling it that this is the end of the message.

4.5 The Print Area

The maximum print area for the M-5900RV is listed in Table 4.1 on Page 4-6. Most of your label applications will not require labels that fill the entire print area, therefore it is important to understand how to work with labels that do not use the entire print area. The goal is to help you avoid printing where no label exists, which may lead to print head damage, not to mention frustration when you cannot see the printed output.

The diagram below illustrates the maximum print area with a sample 2 inch wide by 3 inch long label placed within this area. As can be seen, your label will be oriented against the inside left edge of the printer as viewed from the front of the printer. The normal reference point is located at the H1, V1 position of the print area in the normal print orientation (no rotation).

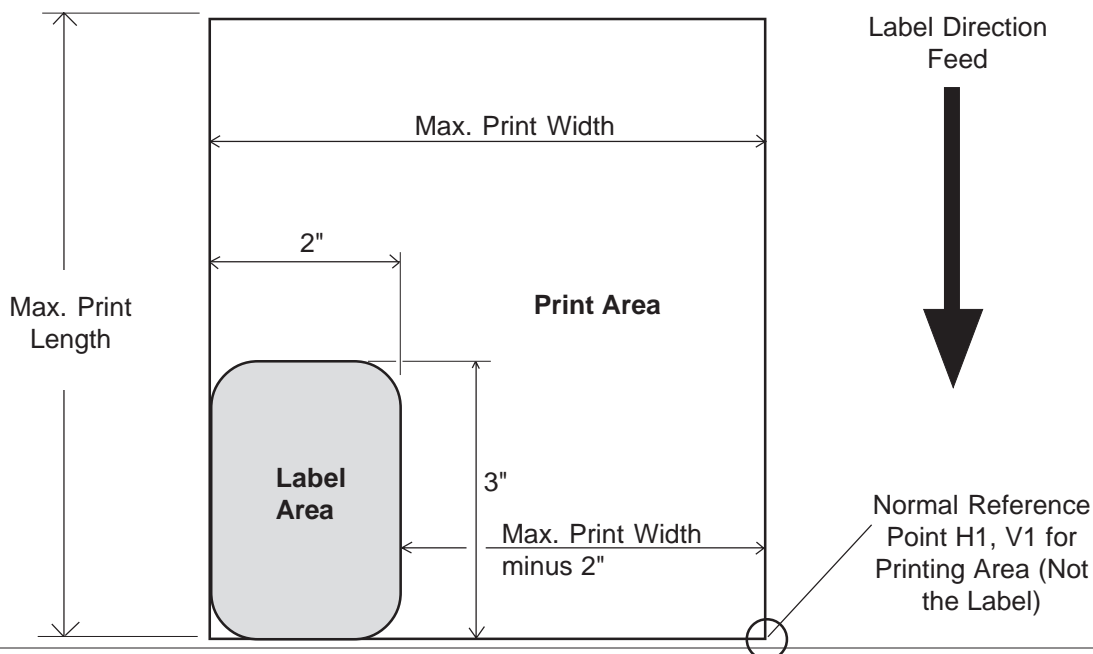

The Print Area

There are two methods available to make sure your printed output will appear correctly on your label. They are as follows:

1. Send the Base Reference Point command as part of your data to the printer to set a new base reference point for your label.

Calculate the distance in dots (1 dot = approx. .005") from the normal base reference point to the closest edge of the label. For an 8 dpmm printer, this would be:

$$\text{Label Width} = 2" \times 25.4 \text{ mm/in} \times 8 \text{ dpmm} = 406 \text{ dots}$$

The new Base Reference Point then becomes:

$$\text{New Base Reference Point} = \text{Maximum Print Width} - \text{Label Width}$$

For the M-5900RV the new Base Reference Point is:

$$\text{New Base Reference Point} = 896 \text{ dots} \text{ minus } 406 \text{ dots} = \mathbf{490} \text{ dots}$$

Issue the Base Reference Point command <ESC>A3 after the Start command in your data Stream.

<ESC>A<ESC>A3H**490**V0001...

This resets the reference point for all the following data.

2. Use the normal base reference point from the print area and use the horizontal position for each field to properly locate it on the label.

Calculate the distance (in dots) from the normal base reference point to the closest edge of the label for an 8 dpmm printer:

$$\text{Label Width} = 2" \times 25.4 \text{ mm/in} \times 8 \text{ dpmm} = 406 \text{ dots}$$

$$\text{New Base Reference Point} = \text{Maximum Print Width} - \text{Label Width}$$

For the M-5900RV printer this becomes:

$$\text{New Base Reference Point} = 896 \text{ dots} - 406 \text{ dots} = 490 \text{ dots}$$

Each <ESC>H command would have the value "490" added to it to correctly position each field.

Note: The <ESC>A3 Base Reference Point command (Page 4-21) can also shift the reference point in a negative direction (toward the outside edge of the label).

The Print Area

The Command Code subsection contains a sample label output for each command code. These samples reflect how the printed information would appear on a five inch wide label. If you want to test any of the sample label outputs and are using labels less than five inches in width, we suggest that you add the Base Reference Point command to the data stream in order for the images to print on your labels. You must be careful not to print off the label surface as the label provides a heat sink for the print head elements. Doing so will cause irreparable damage to the head. This damage is not covered under the print head warranty. The addition of the Base Reference Point command to the sample data stream may help to adjust the print for your labels. See the following two examples or refer to the Base Reference Point command description.

For example, the following illustrates a sample data stream for a M-5900RV printer and the resulting label assuming a 4 inch wide label:

```
<ESC>A
<ESC>H0185<ESC>V0100<ESC>L0303<ESC>XMSATO
<ESC>H0164<ESC>V0200<ESC>B103100*SATO*
<ESC>H0280<ESC>V0310<ESC>L0202<ESC>XUSATO
<ESC>Q1
<ESC>Z
```

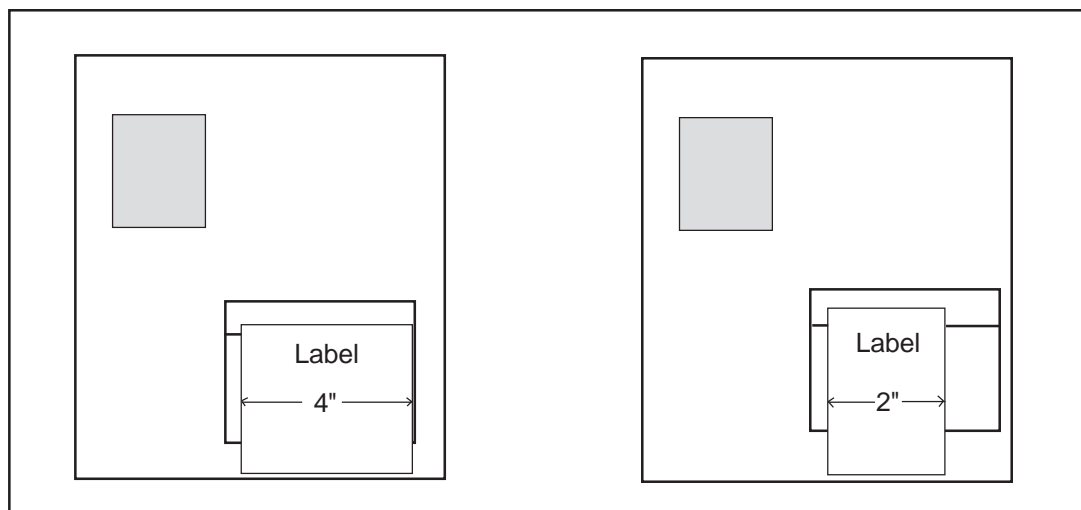

If you are using a 2 inch wide label, the entire image may not appear on your label. By adding the following Base Reference Point command to the second line of the data stream, the base reference point will be changed, causing the image to be shifted over toward the inside of the printer where it can be printed on the narrower label.

```
<ESC>A
<ESC>A3H406V0001
<ESC>H0185<ESC>V0100<ESC>L0303<ESC>XMSATO
<ESC>H0165<ESC>V0200<ESC>B103100"SATO"
<ESC>H0280<ESC>V0310<ESC>L0202<ESC>XUSATO
<ESC>Q1
<ESC>Z
```

The Print Area

The image is moved horizontally to the right 2 inches (406 dots) so that it can be printed on a 2 inch wide label.

For more information, see the Base Reference Point command description.

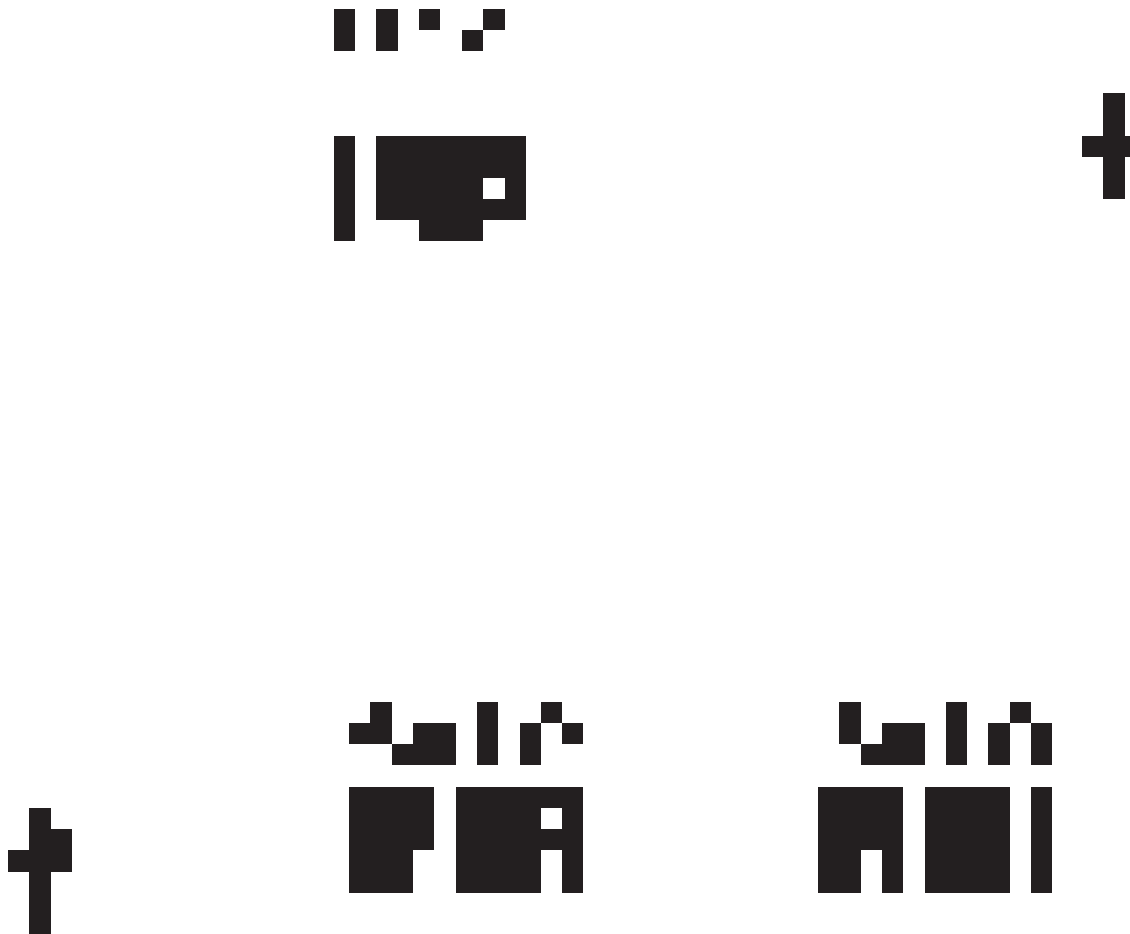

4.6 Rotated Fields

The M-5900RV printer can rotate each print field in 90° increments using the Rotate command. There are two variations of this command.

- <ESC>% - The field rotates, but the base reference point for the field remains the same.
- <ESC>R - The field *and* the base reference point rotate.

The following data stream will rotate the print field but will not change the base reference point of the field.

```
<ESC>A<ESC>%1<ESC>V800<ESC>H200<ESC>L0202<ESC>XB1E<ESC>Q1<ESC>Z
```

The following data stream will rotate both the field and the base reference point for that field.

```
<ESC>A<ESC>R<ESC>V0200<ESC>H0100<ESC>L0202<ESC>P02<ESC>XB1E<ESC>Q1<ESC>Z
```

4.7 Command Default Settings



There are some types of commands that must have a value specified before a label can be printed. If the data stream does not contain these commands, a "default" value is assumed. The commands and the corresponding default values are:

COMMAND	DEFAULT	NOTE
Character Expansion	1	(1)
Print Darkness	2	(1)
Print Speed DSW2-8 On	6 ips	(2)
Print Speed DSW2-8 Off	4 ips	(2)
Proportional Spacing	Enabled	(1)
Cutter Command	Disabled	(1)
Print Rotation	0°	(1)
Vertical Reference Point	0	(1)
Horizontal Reference Point	0	(1)
Character Pitch	2	(1)
Base Reference Point	H=0, V=0	(2)

NOTES:

- (1) The settings for these commands will revert to the default value when the printer receives an **<ESC>Z** or an **<ESC>***.
- (2) The values transmitted with these commands will remain in effect until a new command is received.

4.8 Command Codes

The following pages contain all the RISC printer Command Codes. The commands must be sent to the printer in an organized fashion in order for the label(s) to print.

The purpose of this section is to:

1. Explain the different commands and provide examples of their usage.
2. To provide a detailed reference for programming the M-5900RV printer.

Each command begins on a separate page with its own heading. A uniform layout is used to help you find key information about each command. For each Command Code in this section, there will be a sample data input stream to the printer and the expected print output. By studying the examples, you can learn how to use the particular command within a whole block of printer code. Pay particular attention to the "Special Notes" with each command to learn other important information.

The subject commands are highlighted in bold letters in the Reference Sheets. There are two parts of most, but not all commands. The first is the command character which immediately follows the **<ESC>** code. It is always an upper case alpha or a special character (such as an "&" or a "%"). It is never a lower case alpha character. If the command requires additional variable information, it is represented by a group of lower case alpha characters immediately following the command character. For example, if an **aaaabb** is listed following the basic command, the printer will look for six characters immediately following the command. The first four would represent the value of **aaaa** and the next two the value of **bb**.

The maximum number of characters defined in a parameter is represented by the number of characters shown in the command structure. For example, a command followed by a **aaaa** can have up to four characters. In general, commands with only one parameter following the command can be entered without the leading zeroes. However, certain commands require the exact number of matching characters. A command with two parameters listed following the command code without a comma delimiter, such as **aaaabbbb** require the exact number of digits to be entered. If the value of **aaaa** is "800" and the value of **bbbb** is "300", then the parameters must be entered as "080000300". It is recommended that you make it a practice to always enter leading zeros to prevent any mistakes.

NOTE: These examples assume the use of the Standard Protocol Command Codes, a parallel interface and a 4 inch wide label in a M-5900RV printer. The labels for all other printers will be similar, but because of different resolutions and print widths, may be larger or scaled differently.

An alphabetical listing of the command codes is contained in Appendix A: Command Code Quick Reference.

Bar Codes

Command Structure

1:3 narrow/wide bar ratio: <ESC>**Babbcccd**

2:5 narrow/wide ratio: <ESC>**BDabbcccd**

1:2 narrow/wide bar ratio: <ESC>**Dabbcccd**

a = Bar Code Symbol

- 0 Codabar
- 1 Code 39
- 2 Interleaved 2 of 5 (1 2/5)
- 3 UPC-A / EAN-13
- 4 EAN-8
- 5 Industrial 2 of 5
- 6 Matrix 2 of 5
- 7 reserved
- 8 reserved
- 9 Code 128
- A MSI
- B reserved
- C Code 93
- D reserved
- E UPC-E
- F Bookland
- G Code 128
- I UCC 128

bb = Number of dots (01-12) for narrow bar and narrow space

ccc = Bar height in dots (001-600)

d = UCC 128 only. Not used for other bar code types

- 0 No human readable text
- 1 Human readable at top
- 2 Human readable at bottom

Example: <ESC>**BD103200**

Placement: Immediately preceding data to be encoded

Default: None

Command Function

To print bar code images on a label. With this command, there are 13 standard bar code symbologies available to be printed and three two dimensional symbols (see Two Dimensional bar code symbols starting on Page 4-99). Each of the bar codes are unique, and it is important to know the differences. See Appendix B for specific information on using each individual bar code symbol.

Printer Input

```
<ESC>A
<ESC>H0025<ESC>V0025<ESC>B103100*CODE 39*
<ESC>H0155<ESC>V0130<ESC>XS*CODE 39*
<ESC>H0025<ESC>V0200<ESC>BD20210045676567
<ESC>H0075<ESC>V0310<ESC>XM45676567
<ESC>H0025<ESC>V0375<ESC>BD30215001234567890
<ESC>H0025<ESC>V0600<ESC>BD50210012345
<ESC>H0175<ESC>V0710<ESC>XS12345
<ESC>H0025<ESC>V0775<ESC>BD60210012345
<ESC>H0105<ESC>V0885<ESC>XS12345
<ESC>H0025<ESC>V0950<ESC>BA03100123455
<ESC>H0095<ESC>V1060<ESC>XS12345
<ESC>H0025<ESC>V1125<ESC>BC03100081234ABCD
<ESC>H0080<ESC>V1240<ESC>XS1234ABCD
<ESC>H0525<ESC>V0025<ESC>B002100A12345B
<ESC>H0565<ESC>V0135<ESC>XS12345
<ESC>H0475<ESC>V0200<ESC>BD303100123456789012
<ESC>H0525<ESC>V0375<ESC>BD4031001234567
<ESC>H0525<ESC>V0550<ESC>DE03100123456
<ESC>H0500<ESC>V0600<ESC>OB0
<ESC>H0533<ESC>V0655<ESC>OB123456
<ESC>H0350<ESC>V0725<ESC>D30315009827721123
<ESC>L0101<ESC>H0320<ESC>V0800<ESC>OB0
<ESC>H0365<ESC>V0878<ESC>OB98277
<ESC>H0505<ESC>V0878<ESC>OB21123
<ESC>H0665<ESC>V0760<ESC>BF0313021826
<ESC>H0680<ESC>V0730<ESC>OB21826
<ESC>H0425<ESC>V1125<ESC>D30315000633895260
<ESC>L0101<ESC>H0395<ESC>V1200<ESC>OB0
<ESC>H0440<ESC>V1278<ESC>OB06338
<ESC>H0580<ESC>V1278<ESC>OB95260
<ESC>H0730<ESC>V1155<ESC>BF0314024
<ESC>H0745<ESC>V1125<ESC>OB24
<ESC>H0325<ESC>V0950<ESC>BG03100>GAB>B789>C123456
<ESC>H0435<ESC>V1055<ESC>XSAB789123456
<ESC>Q1<ESC>Z
```

NOTE: Carriage Returns and Line Feeds have been added to the command listing for clarity and should not be included in the actual data stream.

Printer Output

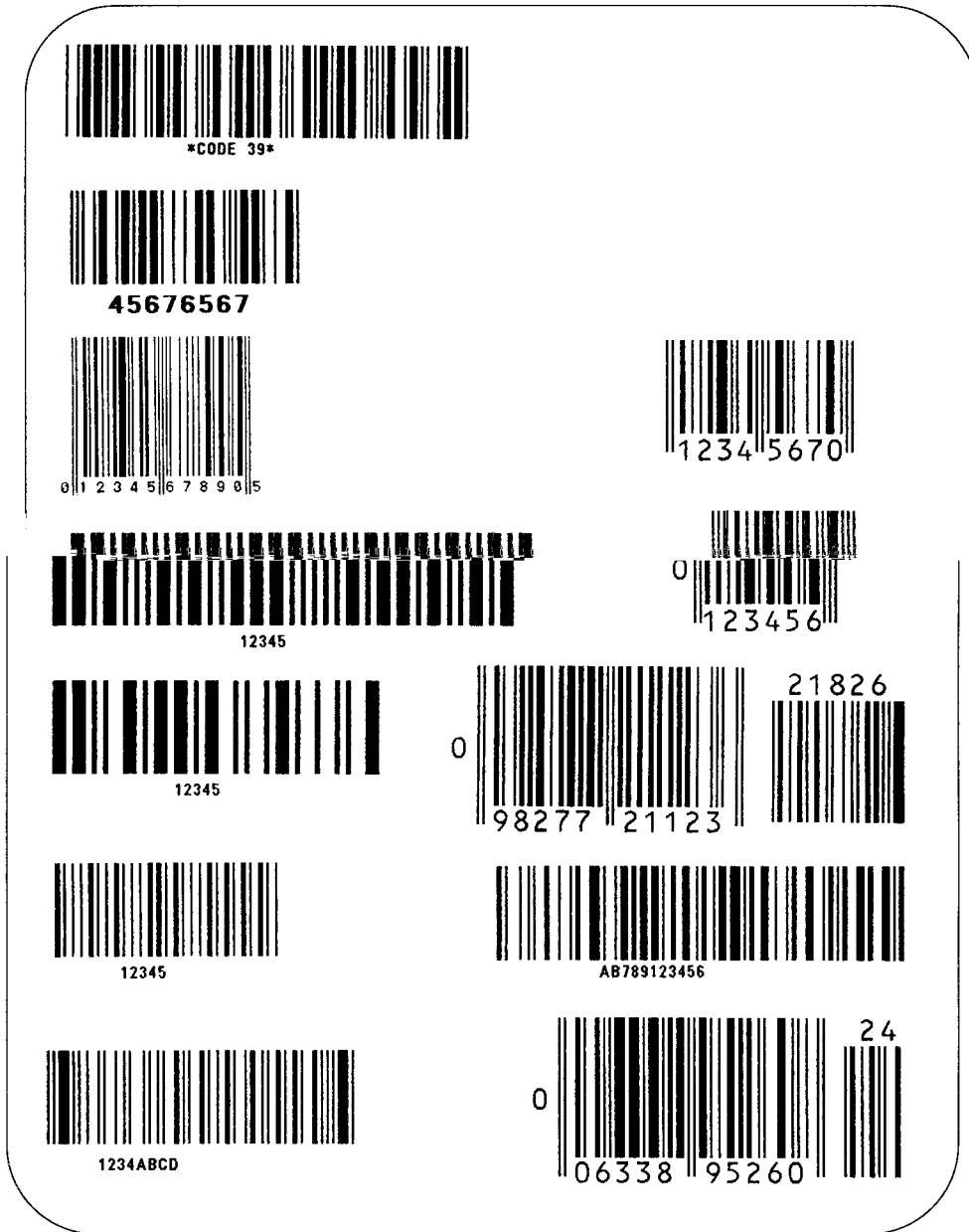

UCC-128

Without Incrementing

<ESC>A
<ESC>H0100<ESC>V0100<ESC>B107150101234567000000001
<ESC>Q2<ESC>Z



With Incrementing

<ESC>A
<ESC>H0100<ESC>V0100<ESC>F001+001<ESC>B107150101234567000000001
<ESC>Q2<ESC>Z



Special Notes

1. UPC and EAN bar codes are not affected by the different types of narrow to wide ratios. Instead, the <ESC>D command adds descender bars to these codes where needed to meet UPC specifications. The <ESC>BD command puts descender bars and human readable text below the symbol.
2. The Code 128, UCC 128, MSI, and Code 93 bar codes are not affected by the narrow to wide ratios.
3. The Codabar, Code 39, Industrial 2 of 5, and Matrix 2 of 5 bar codes are affected by the Character Pitch command. This command must be placed before the Bar Code command.
4. See Appendix B for more specific instructions and detailed information regarding individual bar code symbols.
5. Because of their unique characteristics, two-dimensional symbols are covered separately (see page 4-99).
6. For UCC128, the FNC1 code is automatically inserted and the Mod 10 and Mod 103 check digits are automatically calculated.
7. For the MSI bar code, the check digit is not automatically calculated.

Bar Codes, Expansion

Command Structure

<ESC>BWaabb

aa = Expansion factor by which the width of all bars and spaces will be increased (01-12)

bbb = Bar height by dot (004-600 dots)

Example: **<ESC>BW02100**

Placement: Immediately follows the **<ESC>BT** command and precedes data to be encoded.

Default: None

Command Function

This command works together with the **<ESC>BT** command to specify an expansion factor and the bar code height for the particular symbol being printed.

Input to Printer

```
<ESC>A  
<ESC>H0050<ESC>V0050<ESC>BT001030103<ESC>BW04100*1234*  
<ESC>Q1<ESC>Z
```

Printer Output



Special Notes

1. This command must be preceded by the Variable Ratio Bar Codes **<ESC>BT** command (see Page 4-19).
2. The following bar codes will be affected by the Character Pitch command: Codabar, Code 39, Interleaved 2 of 5, Matrix 2 of 5.

Bar Codes, Variable Ratio

Command Structure

<ESC>BTabbccddee

a = Bar Code Symbol

0 Codabar

1 Code 39

2 Interleaved 2 of 5

5 Industrial 2 of 5

6 Matrix 2 of 5

bb = Narrow space in dots (01-99)

cc = Wide space in dots (01-99)

dd = Narrow bar in dots (01-99)

ee = Wide bar in dots (01-99)

Example: <ESC>**BT**101030103

Placement: Following print position commands and preceding <ESC>BW

Default: Current setting

Command Function

To print a bar code with a ratio other than those specified through the standard bar code commands (B, BD, and D). This is done through individual control of each of the bar code elements (bars, spaces) as shown above. Remember that this command only applies to the five bar code types shown.

Printer Input

<ESC>A

<ESC>H0050<ESC>V0050<ESC>**BT001030103**<ESC>BW03100*1234*

<ESC>Q1<ESC>Z

Printer Output



Special Notes

1. This command must be immediately followed by the <ESC>BW Bar Code Expansion command (see Page 4-18).
2. You may use only one variable ratio bar code per label.
3. If the data specified in this command is incorrect, the command is ignored and the ratio used will be based on the previous setting.
4. See Appendix B for more specific instructions and details regarding individual bar code symbols.

Base Reference Point

Command Structure

<ESC>**A3H-aaaaVbbbb**

- = This character is optional. When present, it specifies that the horizontal offset is in the negative direction. If it is left out the offset direction is positive.

aaaa = Horizontal Print Offset (see Note 5 for field range)

bbbb = Vertical Print Offset (see Note 5 for field range)

Example: <ESC>**A3H100V0050**

Command Function

To establish a new base reference point for the current label. The base reference point is the top left corner or "origin" from where all print position commands are based.

This command may be very helpful when using labels less than four inches wide to place images on the printable label surface. It may also be used to move images past preprinted fields on a label.

Printer Input

```
<ESC>A<ESC>L0202
<ESC>H0025<ESC>V0025<ESC>WB0NORMAL REFERENCE POINT
<ESC>A3H0300V0075
<ESC>H0100<ESC>V0050<ESC>WB0NEW REFERENCE POINT
<ESC>Q1<ESC>Z
```

Printer Output



Special Notes

1. Use of this command will set the Vertical/Horizontal Offset setting of the printer configuration until a new Base Reference Point command is issued or the setting is changed from the operator panel. See Section 2: Installation and Configuration.
2. This command may be used more than once in a print job.
3. An alternative to using this command is to make changes to your current Horizontal and Vertical Print Position commands (see Page 4-61).

Example:

Let's say the current base reference point is H=1, V=1 and you wish to move all the fields on your label downward vertically by 150 dots. You could either:
(1) add the Base Reference Point command or
(2) change all the vertical position commands by an additional 150 dots.

4. For a more detailed example of the Base Reference Point command, see "Print Area" in this section (Page 4-5).
5. The allowable field ranges for this command are:

M-5900RV	
Horizontal aaaa	-0832 to 0896
Vertical bbbb	0001 to 1424

Characters, Custom-Designed

Command Structure

Store Command: <ESC>**T***abcc*

Recall Command: <ESC>**K***ab90cc*

a = 1 16x16 matrix
2 24x24 matrix

b = Specifies the character encoding method for the data stream
H Hexadecimal characters
B Binary characters

cc = Memory location to store/recall the character. Valid memory locations are 21 to 52 (counting in Hex) or "!" to "R" in Binary.

(data) = Data to describe the character

Example: <ESC>**T1H3F**

<ESC>**K1H903F**

See Appendix C for a more detailed explanation.

Placement: The Store command is typically sent in its own data stream to the printer, between the Start/Stop commands. The Recall command is sent in a secondary data stream to print the character and follows any necessary position or size commands.

Default: None

Command Function

To allow for the creation, storage, and printing of custom characters, such as special fonts or logos. Up to 50 individual characters may be stored in the custom character volatile memory.

Printer Input

See Appendix C for a detailed explanation.

<ESC>A

<ESC>**T1H3F**

0100038007C00FE01FF03FF87FFCFFFE07C007C007C007C007C007C007C007C0

<ESC>Z

<ESC>A

<ESC>H150<ESC>V100<ESC>L0505<ESC>**K1H903F**

<ESC>H350<ESC>V100<ESC>L1010<ESC>**K1H903F**

<ESC>Q1<ESC>Z

Printer Output



Special Notes

1. When printing the custom character using the Recall command, the character is affected by the following commands:
 - Character Expansion (see Page 4-25)
 - Character Pitch (see Page 4-28)
 - Line Feed (see Page 4-52)
 - Rotate, Fixed Base Reference Point (see Page 4-70)
 - Rotate, Moving Base Reference Point (see Page 4-72)
2. The characters are stored in volatile memory and must be reloaded if the printer power is lost.
3. Do not use ASCII <CR> or <LF> characters (carriage return or line feed) as line delimiters within the graphic data or the actual image will not be printed as specified.

Characters Expansion

Command Structure

<ESC>Laabb

aa = Multiple to expand horizontally (01-12)

bb = Multiple to expand vertically (01-12)

Example: <ESC>L0305

Placement: Preceding the data to be expanded

Default: <ESC>L0101

Command Function

To expand characters independently in both the horizontal and vertical directions. The command allows you to enlarge the base size of each font (except the vector font) up to 12 times in either direction. Expanded characters are typically used for added emphasis or for long distance readability.

Printer Input

<ESC>A

<ESC>A<ESC>H0100<ESC>V0100<ESC>XMSATO

<ESC>H0100<ESC>V0200<ESC>L0402<ESC>XMSATO

<ESC>H0100<ESC>V0300<ESC>L0204<ESC>XMSATO

<ESC>Q1<ESC>Z

Printer Output

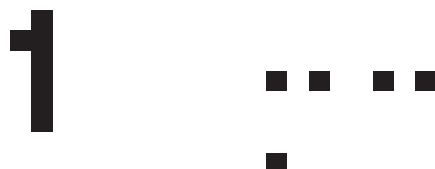

Special Notes

1. This command will expand the following fonts:
Fonts U, S, M, XU, XS, XM, OA, & OB (see Page 4-36) and fonts
WB, WL, XB and XL (see Page 4-40).
2. This command will also affect the following commands:
Character Pitch (see Page 4-28)
Characters, Custom Designed (see Page 4-23)
3. The Character Expansion value is in effect for the current print job until
a new expansion command is specified.
4. The Line and Box command, if used within the data stream, may return
all subsequent text to the default expansion of 1 x 1. Therefore either
send the Character Expansion command before all printed data, or
send Line and Box commands last, preceding the <ESC>Q Quantity
command.

Character, Fixed Spacing

Command Structure

<ESC>PR

Example: See Above

Placement: Preceding the data

Default: The default is Proportional Spacing

Command Function

To reset the proportional spacing and place the printer back to fixed spacing

Printer Input

```
<ESC>A
<ESC>H0025<ESC>V0050<ESC>PS
<ESC>L0202<ESC>XMPROPORTIONAL SPACING
<ESC>H0025<ESC>V0130<ESC>PR
<ESC>L0202<ESC>XMFIXED SPACING
<ESC>Q1<ESC>Z
```

Printer Output



Special Notes

1. This command only works with the proportionally spaced fonts XU, XM, XS, XL and XB.

Character Pitch

Command Structure

<ESC>Paa

aa = Number of dots between characters (00-99)

Example: <ESC>P03

Placement: Preceding the text to be printed

Default: <ESC>P02

Command Function

To designate the amount of spacing (in dots) between characters. This command provides a means of altering character spacing for label constraints or to enhance readability.

Printer Input

<ESC>A

<ESC>H0025<ESC>V0025<ESC>L0202<ESC>XB1SATO

<ESC>H0025<ESC>V0125<ESC>L0202<ESC>P20<ESC>XB1SATO

<ESC>H0025<ESC>V0225<ESC>L0202<ESC>P40<ESC>XB1SATO

<ESC>Q1<ESC>Z

Printer Output

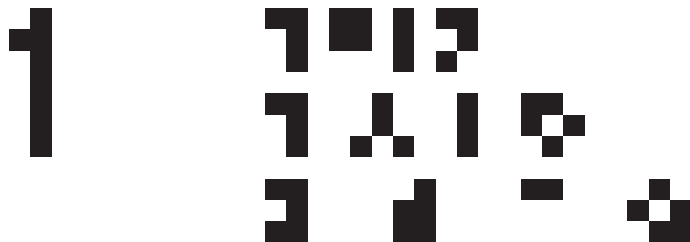

Special Notes

1. This command is affected by the <ESC>L Character Expansion command (see Page 4-25). The character pitch is actually the product of the current horizontal expansion multiple and the designated pitch value.

Example:

```
<ESC>L0304
```

```
<ESC>P03
```

```
Pitch = (03) x (03) = 9 dots
```

2. To avoid confusion, you may want to include the <ESC>L Character Expansion command and this command together in your program.
3. This command affect fonts U, S, M, XU, XS, XM, OA and OB (see Page 4-36), fonts WB, WL, XB, and XL (see Page 4-40), and the vector font (see Page 4-38).
4. Charter Pitch will always revert to the default value unless it is specified before each new font command in the data stream.
5. This command also affects Codabar, Code 39 and Industrial 2 of 5 bar codes.

Character, Proportional Spacing

Command Structure

<ESC>PS

<ESC>PR

Example: See Above

Placement: Preceding the data to be proportional spaced

Default: <ESC>PS

Command Function

To specify the printing of proportional or fixed spacing for proportionally spaced fonts.

Input to Printer

<ESC>A

<ESC>H0025<ESC>V0050<ESC>PS

<ESC>L0202<ESC>XMPROPORTIONAL SPACING

<ESC>H0025<ESC>V0130<ESC>PR

<ESC>L0202<ESC>XMFIXED SPACING

<ESC>Q1<ESC>Z

Printer Output



Special Notes

1. Once this command is sent in the data stream, it is in effect until the end of the print job unless a reset command is sent.

Clear Print Job(s) & Memory

Command Structure

<ESC>*a

a = If the "a" parameter is not included with this command and the printer is in the multi-buffer mode, this command clears all print jobs in the printer memory, including the current print job.

a = If the "a" is included with this command, it specifies the internal memory section to be cleared.

T To clear the custom character memory

& To clear the form overlay memory

X To clear all internal memory

Example: <ESC>*
<ESC>*X

Placement: This command should be sent to the printer as an independent data stream.

Default: None

Command Function

To clear individual memory or buffer areas of the printer.

Printer Input

<ESC>*A

<ESC>*

<ESC>*Z

Printer Output

There is no printer output as a result of this command. The current print job in the buffer will be terminated and all other print jobs in the buffer cleared.

Special Notes

1. See Memory Card Functions for variations of this command used to clear data from the memory Card (Page 4-82).
2. It is not necessary to clear the printer's memory between each print job.
3. The primary purpose of this command is to clear all print jobs in the multi-buffer mode. The "a" parameter can be used in either the multi-buffer or single job mode to clear specific parts of the memory.
4. When the "a" parameter is used, the section of memory specified will not be cleared until the label is printed.

Continuous Forms Printing

Command Structure

None

The printer locates the end of an adhesive label by sensing the backing between labels or through the use of an eye-mark (black rectangle on the reverse side of the backing). It locates the end of a tag from a notch, eye-mark, or a hole between tags. Both sensors should be disabled when printing continuous forms by placing the Label Sensor Selection switch (DSW3-3) in the On position. See Section 2: Installation and Configuration for instructions on configuring the printer using the front panel DIP switch array.

If you will be using continuous labels or tags, the printer must be told to stop feeding in another manner. The length is determined by the position of the last printed image on the label or tag. The printer will stop feeding when this last field is finished printing. The length may be increased with printed spaces (20 hexadecimal) if necessary. There is no command code to control label length.

Copy Image Area

Command Structure

<ESC>WDHaaaaVbbbbXccccYdddd

aaaa = Horizontal position of the top left corner of the area to be copied

bbbb = Vertical position of the top left corner of the area to be copied

cccc = Horizontal length of the image area to be copied

dddd = Vertical length of the image area to be copied

Example: <ESC>WDH0100V0050X0600Y0400

Placement: Anywhere within the data stream, after specifying the location of the duplicate image.

Default: None

Command Function

To copy an image from one location to another on the same label. This may be useful for duplicating individual fields or entire sections of the label with only one command.

Printer Input

```
<ESC>A
<ESC>H0050<ESC>V0050<ESC>E010<ESC>XM
SATOSATOSATOSATOSATOSATOSATO
SATOSATOSATOSATOSATOSATOSATO
SATOSATOSATOSATOSATOSATOSATO
SATOSATOSATOSATOSATOSATOSATO
<ESC>H0180<ESC>V0250<ESC>WDH0165V0050X0400Y0200
<ESC>Q1<ESC>Z
```

Printer Output



Special Notes

1. Use the Print Position commands (V and H) to locate the new area for the duplicate image (see Page 4-61).
2. Position of the new target area must not be inside the original image.
3. If you use the Rotate command, V, H, X and Y axis will be reversed.
4. If the reference area of the target image exceeds the print area, it will not be printed.
5. The allowable field ranges for these fields are as follows:

M-5900RV	
Horizontal aaaa cccc	0001 to 0896
Vertical bbbb dddd	0001 to 1424

Cutter Command

Command Structure

<ESC>~aaaa

aa = Number of labels to print between each cut (01-9999)

Example: <ESC>~**0002**

Placement: Following the Print Quantity command <ESC>Q

Default: <ESC><~>**0001** (if cutter enabled)

Command Function

To control the cutting of labels when using a SATO cutter unit with the printer. This command allows the cutting of a multi-part tag or label at a specified interval within a print job.

Printer Input

```
<ESC>A
<ESC>H0020<ESC>V0020<ESC>WB1TESTLABEL<ESC>Q3
<ESC>0002
<ESC>Z
```

Printer Output

This set of commands will print 6 labels (3 x 2) with two labels between each cut.

Special Notes

1. You must have the optional printer cutter to use this function. Contact your SATO representative for more information.
2. To use this command the printer configuration must have the cutter option enabled. See Installation and Configuration in Section 2 of this manual.
3. If the cutter option has been enabled in the printer configuration and the cut value (aaaa = 0000) the cutter is inactive.

The <NUL> represents the ASCII 00 Hex character and can be interchanged with a tilde character.

4. When using the Cutter command the total number of labels printed is the product of the cut value and the print quantity. For example: If the cut value is 2 and the print quantity is 20 then 20 sets of two labels will be printed.

Fonts U, S, M, OA, OB, XU, XS & XM

Command Structure

Font XU: <ESC>**XU** Font U: <ESC>**U**
Font XS: <ESC>**XS** Font S: <ESC>**S**
Font XM: <ESC>**XM** Font M: <ESC>**M**
Font OA: <ESC>**OA** Font OB: <ESC>**OB**

Example: See above
Placement: Preceding the data to be printed
Default: None

Command Function

To print text images on a label. These are eight of the built-in fonts available on the printer. All matrices include descenders.

	NON-PROPORTIONAL		PROPORTIONAL⁽¹⁾
U	5W x 9H dot matrix	XU	5W x 9H dot matrix
S	8W x 15H dot matrix	XS	17W x 17H dot matrix
M	13W x 20H dot matrix	XM	24W x 24H dot matrix
OA	OCR-A font 15W x 22H dot matrix		
OB	OCR-B font 20W x 24H dot matrix		

(1) These fonts will be printed with proportional spacing only if preceded by an <ESC>PS command.

Printer Input

```
<ESC>A<ESC>PS  
<ESC>H0001<ESC>V0100<ESC>L0202<ESC>XUSATO  
<ESC>H0001<ESC>V0175<ESC>L0202<ESC>XSSATO  
<ESC>H0001<ESC>V0250<ESC>L0202<ESC>XMSATO  
<ESC>H0001<ESC>V0325<ESC>L0101<ESC>OASATO  
<ESC>H0001<ESC>V0400<ESC>L0101<ESC>OBSATO  
<ESC>H0300<ESC>V0100<ESC>L0202<ESC>USATO  
<ESC>H0300<ESC>V0175<ESC>L0202<ESC>SSATO  
<ESC>H0300<ESC>V0250<ESC>L0202<ESC>MSATO  
<ESC>Q1<ESC>Z
```

Printer Output

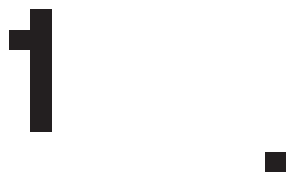

Special Notes

1. Characters may be enlarged through the use of the Character Expansion command (see Page 4-25).
2. Character spacing may be altered through the use of the Character Pitch command (see Page 4-28). The default is 2 dots between characters. It is recommended to use a spacing of 5 dots for OCR-A and 1 dot for OCR-B.
3. You may also create custom characters or fonts. See the <ESC>T Custom-Designed Characters command (Page 4-23).
4. A font must be defined for each field to be printed. There is no default font.
5. Fonts U, S, M, OA and OB are identical to fonts U, S, M, OA and OB on the SATO M-5900RV printer.
6. The proportionally spaced fonts XU, XS, XM, XL and XA can be printed with fixed spacing using the <ESC>PS Proportional Space command.

Font, Vector

Command Structure

Specify Vector Font <ESC>**\$a,b,c,d**
Data for Vector Font <ESC>**\$(data)**

- a = A Helvetica Bold (proportional spacing)
 B Helvetica Bold (fixed spacing)
- b = Font width (50-999)
- c = Font height (50-999 dots)
- d = Font variation (0-9) as follows:

- 0 Standard
- 1 Standard open (outlined)
- 2 Gray (mesh) pattern 1
- 3 Gray (mesh) pattern 2
- 4 Gray (mesh) pattern 3
- 5 Standard open, shadow 1
- 6 Standard open, shadow 2
- 7 Standard mirror image
- 8 Italic
- 9 Italic open, shadow

Example: <ESC>**\$A,100,200,0<ESC>\$(123456)**

Placement: Immediately preceding data to be printed.

Default: None

Command Function

To specify printing of the unique SATO vector font. The vector font allows large characters to be printed with smooth, round edges. Each character is made of a number of vectors (or lines), and will require slightly more printer compiling time.

Printer Input

```
<ESC>A  
<ESC>H0100<ESC>V0100<ESC>$A,100,100,0<ESC>$(SATO America  
<ESC>H0100<ESC>V0200<ESC>$(VECTOR FONT  
<ESC>H0100<ESC>V0350<ESC>$A,200,300,8<ESC>$(SATO  
<ESC>Q1<ESC>Z
```

Printer Output



Special Notes

1. The Pitch command can be used with Vector fonts.
2. If the font size designation is out of the specified range, a default value of 50 is used.
3. The font width and height values include ascenders, descenders and other space.
4. A font must be defined for each field to be printed. There is no default font.

Fonts WB, WL, XB & XL

Command Structure

Font WB: <ESC>**WB**a Font XB: <ESC>**XB**a

Font WL: <ESC>**WL**a Font XL: <ESC>**XL**a

- a = 0 Disables auto-smoothing of font
1 Enables auto-smoothing of font (see notes below)

Example: <ESC>**WB1123456**

Placement: Preceding the data to be printed

Default: None

Command Function

To print text images on a label. These are the four auto-smoothing fonts available on the printer.

	NON-PROPORTIONAL		PROPORTIONAL⁽¹⁾
WB	18W x 30H dot matrix	XB	48W x 48H dot matrix
WL	28W x 52H dot matrix	XL	48W x 48H dot matrix

(1) These fonts will be printed with proportional spacing only if preceded by an <ESC>PS command.

Printer Input

```
<ESC>A<ESC>PS
<ESC>H0001<ESC>V0100<ESC>WBSATO
<ESC>H0001<ESC>V0185<ESC>WBSATO
<ESC>H0001<ESC>V0270<ESC>WLSATO
<ESC>H0001<ESC>V0355<ESC>WLSATO
<ESC>H0300<ESC>V0100<ESC>XBOSATO
<ESC>H0300<ESC>V0185<ESC>XB1SATO
<ESC>H0300<ESC>V0270<ESC>XL0SATO
<ESC>H0300<ESC>V0355<ESC>XLSATO
<ESC>Q1<ESC>Z
```

Printer Output

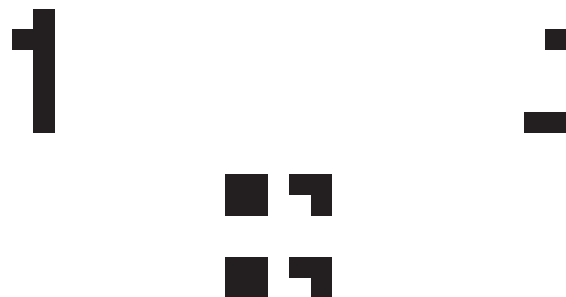

Special Notes

1. Auto-smoothing (when enabled) is only effective if the character expansion rate is at least (3) times in each direction.
2. Characters may be enlarged through the use of the <ESC>L Character Expansion command (see Page 4-25).
3. Character spacing may be altered through the use of the <ESC>A Character Pitch command (see Page 4-28).
4. A font must be defined for each field to be printed. There is no default font.
5. The proportionally spaced fonts XU, XS, XM, XL and XB can be printed with fixed spacing using the <ESC>PS Proportional Space command.

Form Feed

Command Structure

<ESC>A(space)<ESC>Z

Example: See above

Placement: Separate data stream sent to printer

Default: None

Command Function

To feed a blank tag or label, which is the equivalent of a "form feed"

Printer Input

<ESC>A(space)

<ESC>Z

Printer Output

Blank label or tag

Form Overlay, Recall

Command Structure

<ESC>/

Example: See above

Placement: Must be preceded by all other data and placed just before the Print Quantity command (<ESC>Q).

Default: None

Command Function

To recall the label image from the form overlay memory for printing. This command recalls a stored image from the overlay memory. Additional or different data can be printed with the recalled image.

Printer Input

```
<ESC>A
<ESC>H0001<ESC>V0125
<ESC>STHIS IS THE STORED IMAGE WITH A BARCODE
<ESC>H0001<ESC>V0165<ESC>B103100*12345*
<ESC>&<ESC>Z
```

```
<ESC>A<ESC>H0001<ESC>V0050
<ESC>STHIS IS RECALLING AND ADDING TO THE STORED IMAGE<ESC>/
<ESC>Q1<ESC>Z
```

Printer Output



Special Notes

1. The overlay is stored using the <ESC>& Form Overlay Store command (see Page 4-44).
2. If this command is used with the <ESC>AX Expanded Print Length command (see Page 4-59) the Form Overlay length cannot exceed 14".

Form Overlay, Store

Command Structure

<ESC>&

Example: See above

Placement: Must be preceded by all other data and placed just before the Stop command (<ESC>Z).

Default: None

Command Function

To store a label image in the volatile form overlay memory. Only one label image may be stored in this memory area at a time.

Printer Input

```
<ESC>A
<ESC>H0001<ESC>V0125
<ESC>STHIS IS THE STORED IMAGE WITH A BARCODE
<ESC>H0001<ESC>V0165<ESC>B103100*12345*
<ESC>&
<ESC>Z
```

Printer Output

There is no output from this command. It stores the label image in the overlay buffer.

Special Notes

1. Remember that this storage is volatile. Therefore, if the printer loses power, the overlay must be sent again.
2. The overlay is recalled using the <ESC>/ Form Overlay Recall command (see Page 4-43).
3. Form overlays do not have to be recompiled each time they are called to be printed and therefore may result in much faster print output.

Graphics, Custom

Command Structure

<ESC>**G**bbbccc(data)

a = Specifies format of data stream to follow
 B Binary format
 H Hexadecimal format

bbb= Number of horizontal 8 x 8 blocks (001-248)

ccc = Number of vertical 8 x 8 blocks (001-267)

(data) = Hex data to describe the graphic image

Example: <ESC> GH006006
 See Appendix C for a detailed example

Placement: May be placed anywhere within the data stream after the
 necessary position commands.

Default: None

Command Function

To create and print custom graphics (logos, pictures, etc.) on a label. The graphic image may be printed along with other printed data to enhance label appearance or eliminate the need for preprinted label stock. Using a dot-addressable matrix, design the graphic image in 8 dot by 8 dot blocks, then send it in a binary format to the printer.

Printer Input

```
<ESC>A
<ESC>H0100<ESC>V0100<ESC>GH006006
FFFFFFFFFFFFFFFFFFFFFFFFC00000000003
C00000000003C000FFFFFFFF3C00080000013
C00080000013C0009FFFFFF13C00080000013
C00080000013C0009FFFFFF13C00080000013
C00080000013C000FFFFFFFF3C00000000003
C00080000003C00000000003C00000000003
C00007E00003C0000FF00003C0000FF00003
C0000FF00003C0000FF00003C00007F00003
C00003C00003C00003C00003C00003C00003
C00003C00003C00003C00003C00003C00003
C00003C00003C00003C00003C00003C00003
C00003C00003C00001800003C00000000003
C00000000003FFFFFFFFFFFFFFFFFFFFFFFF
<ESC>H0300<ESC>V0100<ESC>XSPLEASE PLACE YOUR DISK
<ESC>H0300<ESC>V0150<ESC>XSIN A SAFE PLACE
<ESC>Q1<ESC>Z
```

See Appendix C for details on the data format.

Printer Output



Special Notes

1. Do not use ASCII <CR> or <LF> characters (carriage return or line feed) as line delimiters within the graphics data or the actual image will not be printed as specified.
2. A custom graphic cannot be enlarged by the <ESC>L Character Expansion command (Page 4-25).
3. A custom graphic is not affected by either of the Rotation commands. Therefore always design and locate your graphic image to print in the appropriate orientation.
4. Use an optional Memory Card to expand the print length.
5. To store graphic images in an optional memory card, see the Memory Card Functions section.
6. The binary format reduces the transmission time by 50%.

Graphics, PCX

Command Structure

<ESC>**GP**aaaa,(data)

aaaaa = Number of bytes to be downloaded

Example: <ESC> **GP32000**, ... data...

Placement: Anywhere within the job data stream

Default: None

Command Function

To allow the creation and printing of graphic images using a PCX file format.

Printer Input

See Appendix C for a detailed example

<ESC>A

<ESC>V0150<ESC>H0100<ESC>**GP03800**, (...Data...)

<ESC>Q1

<ESC>Z

Printer Output



Special Notes

1. The maximum number of bytes that can be downloaded is 32K (compressed). The number specified by this command includes the PCX header information. The maximum size of the uncompressed PCX file is 64K. If the uncompressed file exceeds 64K the graphic will not print.
2. Only black and white PCX files can be downloaded.
3. The file size specified by this command is the DOS file size in bytes.

Job ID Store

Command Structure

<ESC>IDaa

aa = Job ID assigned (01 to 99)

Example: <ESC> ID09

Placement: Immediately following the <ESC>A in the job data stream.

Default: None

Command Function

To add an identification number to a job. The status of the job can then be determined using the ENQ command in the BI-Com status mode (See Section 5: Interface Specification for more information).

Printer Input

<ESC>A

<ESC>ID02

...Job...

<ESC>Z

Printer Output

There is not printer output as a result of this command.

Special Notes

1. Works only in Bi-Com mode. The Job ID number must be stored before Bi-Com status mode can be used.

2. If more than one ID number is sent in a single job, i.e.

<ESC>A

<ESC>ID01

.....

<ESC>ID02

.....

the last number transmitted will be used.

Journal Print

Command Structure

<ESC>J

Example: See above

Placement: Immediately following the <ESC>A

Default: None

Command Function

To print text in a line by line format on a label. By specifying this command, you automatically select Font S with a Character Expansion of 2 x 2. You also establish a base reference point of H2, V2. The character pitch is 2 dots and the line gap is 16 dots. Simply issue an ASCII<CR> at the end of each text line.

Printer Input

<ESC>A

<ESC>J WITH THE JOURNAL FEATURE

YOU CAN PRINT TEXT WITHOUT

USING ANY FONT COMMANDS

OR POSITION COMMANDS

<ESC>Q1<ESC>Z

Printer Output

1

Special Notes

1. Journal mode assumes a maximum label width. Otherwise, you may print where there is no label and damage your print head.
2. It is effective only for the current print job.

Lines and Boxes

Command Structure

Line <ESC>**FWaabcccc**

aa = Width of horizontal line in dots (01-99)

b = Line orientation
H Horizontal line
V Vertical line

cccc = Length of line in dots (see Note 2 for max length)

Box: <ESC>**FWaabbVccccHdddd**

aa = Width of horizontal side in dots (01-99)

bb = Width of vertical side in dots (01-99)

cccc = Length of vertical side in dots (see Note 2 for max length)

dddd = Length of horizontal side in dots (see Note 2 for max length)

Example: <ESC> **FW02H0200**

Placement: Follow the necessary positioning commands

Default: None

Command Function

To print horizontal lines, vertical lines and boxes as images on the label.

Printer Input

<ESC>A

<ESC>H0100<ESC>V0100<ESC>**FW20H0200**

<ESC>H0320<ESC>V0100<ESC>**FW20V0200**

<ESC>H0350<ESC>V0100<ESC>**FW1010H0200V0200**

<ESC>Q1<ESC>Z

Lines and Boxes

Printer Output



Special Notes

1. It is recommended that all lines and boxes be specified in the normal print direction.

LINE/BOX LENGTH	M-5900RV
Horizontal cccc	0001 to 0896
Vertical cccc	0001 to 1424 001 to 2824 (Expanded Print Length)

Line Feed

Command Structure

<ESC>Eaaa

aaa = Number of dots (001-999) between the bottom of the characters on one line to the top of the characters on the next line.

Example: <ESC> E010

Placement: Preceding the text that will use the line feed function

Default: None

Command Function

To print multiple lines of the same character size without specifying a new print position for each line. With the Line Feed command, specify the number of dots you want between each line. Then send an ASCII <CR> at the end of each line of text. The printer automatically identifies the size of the last character, moves down the number of dots specified, and begins printing the next line.

Printer Input

<ESC>A

<ESC>E010<ESC>H0050<ESC>V0050<ESC>L0202<ESC>S

THIS IS THE 1ST LINE

THIS IS THE 2ND LINE

THIS IS THE 3RD LINE

<ESC>Q1<ESC>Z

Printer Output

1

Line Feed

Special Notes

1. This command can be used for text and for bar codes.
2. It is effective only for the current data stream.
3. When printing lines or boxes in the same data stream with the Line Feed command, the Lines and Boxes command should be specified last, preceding <ESC>Q Quantity command.
4. This command is invalid only if the value specified is zero.
5. The rotation command can be used with this command.
6. Following this command with a <CR> character will allow you to print with auto line feed. In this case, the print position will be determined from the value specified in the command and the H value set in the printer. However, if you specify several H values after this command, the print position will be determined by the H value last specified. You must redefine the font to be used after each H command.

Mirror Image

Command Structure

<ESC>Hhhh<ESC>Vvvv<ESC>**RMaaa,bbbb**

hhh = Horizontal position of the top left corner of the area to be mirrored
(see Print Position commands on Page 4-61)

vvv = Vertical position of the top left corner of the area to be mirrored (see
Print Position commands on Page 4-61)

aaa = Horizontal length in dots of the area to be mirrored (0008 to 0896)

bbbb = Vertical length in dots of the area to be mirrored (0008 to 1424)

Example: <ESC>H100<ESC>V100<ESC>**RM0150,0050**

Placement: After fields to be mirrored

Default: None

Command Function

To allow mirror image printing of data, such as on transparent labels to be applied to a glass or other transparent surface.

Printer Input

Label #1

```
<ESC>A<ESC>H0100<ESC>V0050<ESC><XL0ABCDEF
<ESC>RM
<ESC>Q1<ESC>Z
```

Label #2

```
<ESC>A<ESC>H0100<ESC>V0050<ESC><XL0ABCDEF
<ESC>V0050<ESC>H0100<ESC>RM150,0100
```

Label #3

```
<ESC>A<ESC>%1<ESC>H0100<ESC>V0100<ESC><XL0ABCDEF
<ESC>RM
<ESC>Q1<ESC>Z
```

Label #4

```
<ESC>A<ESC>H0100<ESC>V0100<ESC><XL0ABCDEF
<ESC>%1<ESC>RM
<ESC>V0100<ESC>H0100<ESC><XL0ABCDEF
<ESC>Q1<ESC>Z
```

Printer Output

Label #1



Printer Output



Special Notes

1. If Vertical and Horizontal position is not specified in the command, all data preceding the command will be mirrored.
2. This command can be used with the <ESC>% Rotate Fixed Base Reference Point command (see Page 5-70). It cannot be used with the <ESC>R Rotate Moving Base Reference Point command (see Page 5-72). Please note that the reference point rotation is dependent upon the location of the <ESC>% command in the data stream.
3. This command should not be specified more than once in any single job.
4. This command cannot be used with commands requiring re-editing of the print area such as Sequential Numbering, Real time clock, or Copy Image Area.
5. Any data outside the printable area is not mirrored and the command is treated as a command error. Any print job containing the <ESC>RM command and without any print data will be treated as a command error.

Off-Line/Pause

Command Structure

<ESC>@,nn...n

nn...n = Optional message to be displayed on the LCD. Maximum of 32 characters

Example: See above

Placement: Anywhere in the print job location between <ESC>A and <ESC>Z

Default: None

Command Function

To specify the printer to come to an off-line state. When used within a print job, the printer goes off-line after finishing the print job.

Printer Input

<ESC>A

<ESC>@,Load Blue Labels and place printer On-Line

...Job...

<ESC>Z

Printer Output

There is no printer output for this command. The printer is placed in the Off-Line mode as soon as the current print job is finished.

Special Notes

1. You must press the LINE key on the front panel to return the printer to an On-Line status (see Operator Panel in Section 2 of this manual).
2. Remember, when using this command that if the print job specifies <ESC>Q10, all ten labels will print before the printer will go off-line.

Postnet

Command Structure

<ESC>**BPn...n**

n...n = 5 digits (Postnet-32 format)
 6 digits (Postnet-37 format)
 9 digits (Postnet-52 format)
 11 digits (Postnet-62, Delivery Point format)

Example: <ESC>**BP123456789**

Placement: Immediately preceding the data to be encoded

Default: None

Command Function

To print Postnet bar codes

Printer Input

<ESC>A

<ESC>H0100<ESC>V0120<ESC>**BP94089**

<ESC>H0100<ESC>V0160<ESC>**BP123456**

<ESC>H0100<ESC>V0200<ESC>**BP123456789**

<ESC>H0100<ESC>V0240<ESC>**BP12345678901**

<ESC>Q1<ESC>Z

Printer

Output



Special Notes

1. If the number of data digits does not match those listed, the command is ignored.
2. Only numeric data will be accepted.

Print Darkness

Command Structure

<ESC>#Ea

a = Print darkness value
(see Note 2 for allowable setting)

Example: <ESC>#E2

Placement: Must be placed immediately after <ESC>A and immediately before <ESC>Z in its own separate data stream.

Default: See Note 2

Command Function

To specify a new print darkness setting. This command allows software control of the darkness setting for unique media and ribbon combinations.

Printer Input

<ESC>A
<ESC>#E2
<ESC>Z

Printer Output

There is no printer output for this command.

Special Notes

1. This becomes the new setting in the printer configuration for all subsequent print jobs unless changed. The setting is stored in non-volatile memory and is not affected by cycling power.
2. The allowable Print Darkness settings are as follows:

M-5900RV	
Darkness Settings	1,2,3,4,or 5

Default values are shown in **bold** type

Print Length, Expanded

Command Structure

<ESC>**AX** Sets the print length to 14" (356 mm)

<ESC>**AR** Resets the maximum print length to 7" (178 mm)

Example: See above

Placement: Must follow the Start Code command (see Page 4-76) and be in its own separate data stream.

Default: <ESC>**AR**

Command Function

To double the maximum print length (in feed direction) for a label.

Printer Input

<ESC>**A**
<ESC>**AX**
<ESC>**Z**

<ESC>**A**
<ESC>**H0050**<ESC>**V0100**<ESC>**WB1EXPAND TO:**
<ESC>**H0050**<ESC>**V2700**<ESC>**WB114 INCHES**
<ESC>**Z**

<ESC>**A**
<ESC>**AR**
<ESC>**Z**

Printer Output

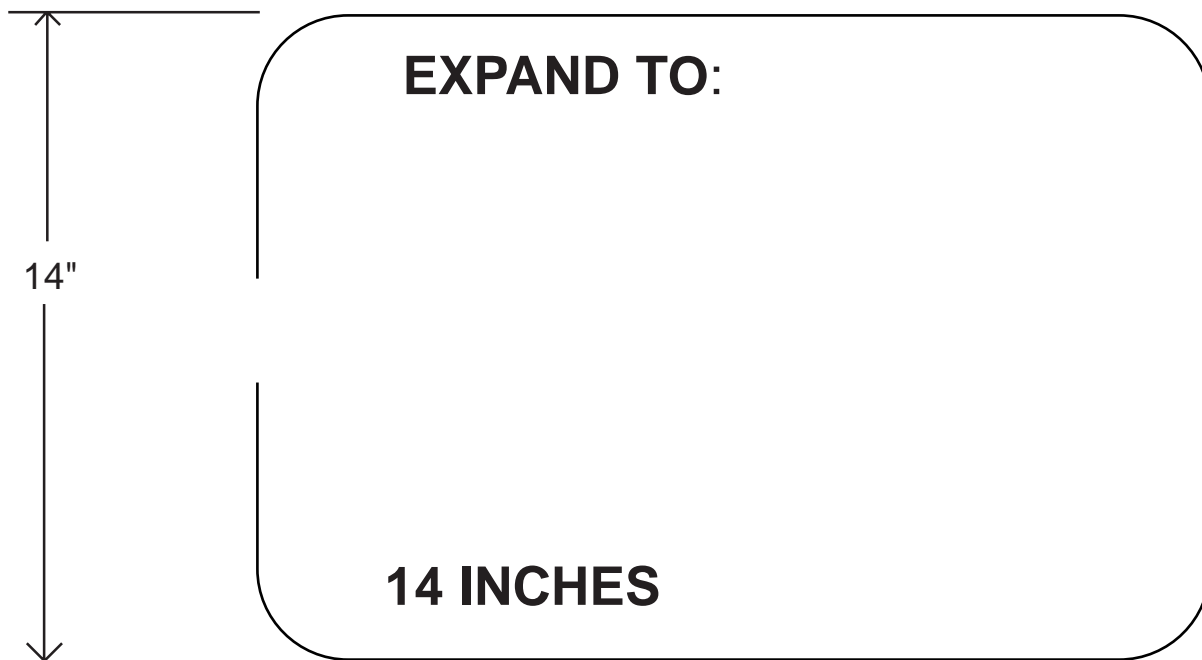

Print Length, Expanded

Special Notes

1. AX is effective until AR is sent to reset the printer to its standard print length or until the printer is repowered.
2. It may be included in an independent data stream to specify the size of the maximum print area:

LENGTH	M-5900RV
<ESC>A <ESC>AX <ESC>Z	14" 2848 dots
ESC>A <ESC>AR <ESC>Z	7" 1424 dots

3. When this command is used with the <ESC>& Store Form Overlay command (see Page 4-44) the Form length cannot exceed 14".

Print Position

Command Structure

Horizontal Position: <ESC>**Haaaa**

Vertical Position: <ESC>**Vbbbb**

aaaa = Number of dots horizontally from the base reference point (1 to maximum) see Note 2.

bbbb = Number of dots vertically from the base reference point (1 to maximum) see Note 2.

Example: <ESC>**H0020**<ESC>**V0150**

Placement: Preceding any printed field description of lines/boxes, fonts, bar codes or graphics.

Default: <ESC>H0001
<ESC>V0001

Command Function

The Horizontal and Vertical commands specify the top left corner of a field or label, using the current base reference point as an origin. They also establish a reference point for subsequent fields until the next horizontal and/or vertical print position command is issued.

Printer Input

```
<ESC>A
<ESC>H0025<ESC>V0050<ESC><L0303<ESC>MSATO
<ESC>H0100<ESC>V0150<ESC>MSATO
<ESC>Q1<ESC>Z
```

Printer Output



Special Notes

1. The print position of a field is affected by both the Rotate (<ESC>R and <ESC>A3) commands.
2. For print lengths greater than 14 inches an optional Memory Card must be used.

Print Position

M-5900RV	
Maximum Print Width aaaa	896 dots 4.4 in. 112 mm
Standard Print Length bbbb	1424 dots 7.0 in. 178 mm
Expanded with <ESC>AX bbbb	2848 dots 14.0 in. 356 mm
Maximum Length with Memory Card ⁽²⁾	
128 Kbyte bbbb	1257 dots 6.2 in. 157 mm
512 Kbyte bbbb	5038 dots 24.8 in. 629 mm
1 Mbyte bbbb	9999 dots ⁽¹⁾ 49.2 in. 1249 mm
2 Mbyte bbbb	9999 dots ⁽¹⁾ 49.2 in. 1249 mm

(1) Limited by the number of digits in the command field

(2) When a Memory Card is used to expand the print length, the card capacity is used instead of the internal memory, not in addition to the internal memory.

Special Notes (cont.)

3. If any part of an image is placed past the maximum number of dots for standard length and or the capacity of the memory card, that part of the image will be lost.
4. If any part of an image is placed past maximum allowable dots across the label, that part of the image will be lost.
5. If you attempt to print where there is no paper, you may damage the print head.
6. For these commands, the leading zeroes do not have to be entered. The command V1 is equivalent to V0001.

Print Quantity

Command Structure

<ESC>Qaaaaaa

aaaaaa = Total number of labels to print (1-999999)

Example: <ESC> Q500

Placement: Just preceding <ESC>Z unless <ESC>NUL exists, then preceding that.
This command must be present in every print job.

Default: None

Command Function

To specify the total number of labels to print for a given print job.

Printer Input

<ESC>A
<ESC>H0100<ESC>V0100<ESC>WB1M-5900RV
<ESC>Q3
<ESC>Z

Printer Output

Three labels containing the "M-5900RV" will be printed.

Special Notes

1. To pause during a print job, you must press the LINE key on the Operator Panel.
2. To cancel a print job, you must turn off the printer or you may send the <CAN> code if using the Bi-Com mode. Multi-Buffer jobs can be cleared with the <ESC>* Clear Print Job(s) and Memory command (See Page 4-31).
3. When used with the <ESC>F Sequential Numbering command (see Page 4-xx, the Print Quantity value should be equal to the total number of labels to be printed.
4. If you do not specify a Print Quantity, the printer will not print a label.
5. For these commands, the leading zeroes do not have to be entered. The command Q1 is equivalent to Q000001.

Print Speed

Command Structure

<ESC>**CSa**

a = Designates the speed selection
See Note 2 for allowable settings

Example: <ESC>**CS5**

Placement: Must be placed immediately after <ESC>A and immediately before <ESC>Z in its own separate data stream.

Default: As previously set in the printer configuration

Command Function

To specify a unique print speed through software for a particular label. This allows flexibility in finding the best performance and quality for the particular label format, media, and ribbon. All subsequent labels will print at this speed unless the speed is changed with this command or through the Operator Panel.

Printer Input

<ESC>A
<ESC>**CS5**
<ESC>Z

Printer Output

There is no printer output for this command. It sets the print speed of the printer.

Special Notes

1. This becomes the new setting in the printer configuration for all subsequent print jobs unless changed. The setting is stored in non-volatile memory and is not affected by cycling the power.
2. The allowable Print Speed settings are as follows:

CS Command	
2	2"/s (50mm/s)
3	3"/s (75mm/s)
4	4"/s (100mm/s)
5	4.7"/s (120mm/s)

Default values are shown in **bold** type.

Repeat Label

Command Structure

<ESC>C

Example: See above

Placement: Must be placed immediately after <ESC>A and immediately before <ESC>Z in its own separate data stream.

Default: None

Command Function

To print duplicate of the last label printed

Printer Input

<ESC>A

<ESC>C

<ESC>Z

Printer Output

A duplicate of the previous label will be printed.

Special Notes

This command will have no effect if the power to the printer was cycled off and back on since printing the previous label.

Replace Data (Partial Edit)

Command Structure

<ESC>0 (<ESC>zero)

Example: See above

Placement: Must follow <ESC>A and precede all other print data

Default: None

Command Function

To replace a specified area of the previous label with new data. This command will cause the previous label to print along with any changes specified within the current data stream.

Printer Input

```
<ESC>A  
<ESC>H0025<ESC>V0020<ESC>WB0Company Name  
<ESC>H0025<ESC>V0085<ESC>WB1SATO  
<ESC>H0025<ESC>V0150<ESC>WL0SATO  
<ESC>H0025<ESC>V0215<ESC>WL1SATO  
<ESC>Q1<ESC>Z
```

```
<ESC>A  
<ESC>0<ESC>V0025<ESC>V0020<ESC>WB0SATO  
<ESC>Q1<ESC>Z
```

Replace Data (Partial Edit)

Printer Output

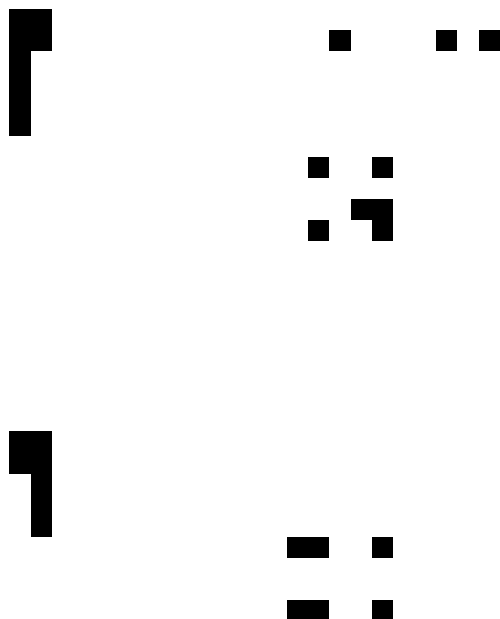

Special Notes

1. Specify the exact same parameters for the image to be replaced as were specified in the original data stream, including rotation, expansion, pitch, etc. This will ensure that the new data will exactly replace the old image. If the replacement data contains fewer characters than the old data, then the characters not replaced will still be printed.
2. This command will not function if the power has been cycled off and back on since the last label was printed.
3. Proportional Pitch text cannot be used with this command.

Reverse Image

Command Structure

<ESC>(aaaa,bbbb

a = Horizontal length in dots of reverse image area

b = Vertical height in dots of reverse image area

See Note 6 for field ranges

Example: <ESC>(100,50

Placement: This command must be preceded by all other data and be placed just before <ESC>Q

Default: None

Command Function

To reverse an image area from black to white and vice versa. Use the Print Position commands (<ESC>H and <ESC>V) to locate the top left corner of the reverse image area.

Printer Input

<ESC>A

<ESC>H0050<ESC>V0120<ESC>L0202<ESC>WB1REVERSE

<ESC>H0250<ESC>V0300<ESC>L0202<ESC>WB1HALF

<ESC>H0040<ESC>V0110<ESC>(370,100

<ESC>H0240<ESC>V0290<ESC>(220,47

<ESC>Q1<ESC>Z

Printer Output

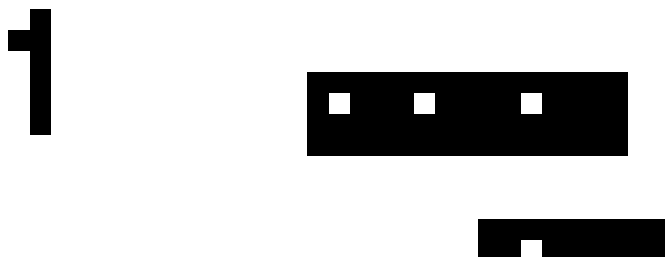

Reverse Image

Special Notes

1. A reverse image area is affected by the rotate commands. Therefore, always assume the printer is in the normal print orientation when designing and sending the Reverse Image command.
2. If using reverse images with the form overlay, place this command before the Form Overlay command in the data stream.
3. If the Rotate commands are used with this command, the V and H parameters are reversed.
4. If the height and width to be reversed contain other than alphanumeric data, the area is not printed.
5. If the values specified exceed the maximum ranges, the reverse image is not created.
6. The maximum allowable settings are as follows:

M-5900RV	
Horizontal aaaa	0001 to 0869
Vertical bbbb	0001 to 1424

Rotate, Fixed Base Reference Point

Command Structure

<ESC>%a

- a = 0 Sets print to normal direction
1 Sets print to 90° CCW
2 Sets print to 180° rotated (upside down)
3 Sets print to 270° CCW

Example: <ESC>%3

Placement: Preceding any printed data to be rotated

Default: <ESC>%0

Command Function

To rotate the print direction in 90° increments without changing the location of the base reference point. The diagram below illustrates the use of the <ESC>% Rotate command. Note that the entire print area is shown, but your label will probably not be as large as the entire area.

Printer Input

```
<ESC>A
<ESC>%0<ESC>H0200<ESC>V0100<ESC>MNORMAL DIRECTION
<ESC>%1<ESC>H0200<ESC>V0300<ESC>MONE
<ESC>%2<ESC>H0200<ESC>V0400<ESC>MTWO
<ESC>%3<ESC>H0200<ESC>V0500<ESC>MTHREE
<ESC>Q1<ESC>Z
```

Rotate, Fixed Base Reference Point

Printer Output

1

Special Notes

1. Do not combine this command and the <ESC>R Rotate command (see Page 4-72) in the same data stream.
2. The specified values are valid until another Rotate (<ESC>%) command is received.
3. Receipt of a Stop Print (<ESC>Z) command will reset the setting to the default value.

Rotate, Moving Base Reference Point

Command Structure

Normal Direction <ESC>N

Rotated Direction <ESC>R

Example: See above

Placement: Preceding any printed data to be rotated

Default: <ESC>N

Command Function

The <ESC>R command rotates the printing of all subsequent images in a print job by 90° counterclockwise each time it is used. It also moves the base reference point to a different corner of the print area.

The <ESC>N command returns to the original base reference point and returns printing to the normal orientation.

Printer Input

<ESC>A

<ESC>N<ESC>H0100<ESC>V0010<ESC>MNORMAL DIRECTION

<ESC>R<ESC>H0400<ESC>V0100<ESC>MONE

<ESC>R<ESC>H0100<ESC>V0400<ESC>MTWO

<ESC>R<ESC>H0100<ESC>V0100<ESC>MTHREE

<ESC>R<ESC>H0100<ESC>V0100<ESC>MFOUR

<ESC>Q1<ESC>Z

Printer Output

1

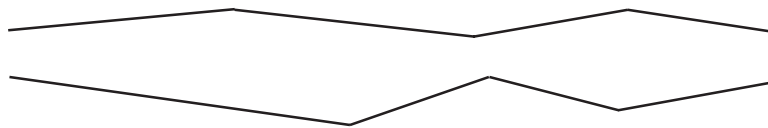

Rotate, Moving Base Reference Point

Special Notes

1. Do not combine this command and the <ESC>% Rotate command (see Page 4-70) in the same data stream.
2. A custom graphic is not affected by this command. Therefore always design and locate your graphic image to print in the appropriate orientation.
3. See Section 4, Rotated Fields, Page 4-10 for more information.
4. The specified values are valid until another Rotate (<ESC>R) command is received.
5. Receipt of a Stop Print (<ESC>Z) command will reset the setting to the default value.

Sequential Numbering

Command Structure

<ESC>Faaaabcccc,dd,ee

aaaa = Number of times to repeat the same data (0001-9999)

b = Plus or minus symbol (+ for increments; - for decrements)

cccc = Value of step for sequence (0001-9999)

,dd = Number of digits for sequential numbering (01-99). The first incrementing character position starts after the positions exempted from sequential numbering as specified in ee. If these digits are left out the default is 8.

,ee = Number of digits free from sequential numbering (00-99) starting with the right most position. If these digits are left out, the default is 0.

Example: <ESC>F001-001,04,03

Decrementing

004321321

Free from Decrementing

In this example, the right most (least significant) three digits would not decrement and the next four would decrement.

Placement: Preceding the starting value to be incremented or decrement.

Default: None

Command Function

To allow the ability to print sequential fields (text, bar codes) where all incrementing is done within the printer. Up to eight different sequential fields can be specified per label. Sequencing is effective for up to 99-digit numeric data within each field.

Printer Input

```
<ESC>A<ESC>H0100<ESC>V0100<ESC>MSERIAL NUMBER:
<ESC>H0100<ESC>V0200<ESC>F001+005
<ESC>L0202<ESC>M1000
<ESC>Q2<ESC>Z
```

Sequential Numbering

Printer Output

1

1

■

Special Notes

1. The value specified for Print Quantity (see Page 4-63) should be equal to the number of different sequential values desired multiplied by the number of repeats specified.

Example:

To print 2 sets each of the numbers 1001-1025 on separate labels, we need 50 total labels. The commands would be as follows:

```
<ESC>A
<ESC>H0100<ESC>V0100<ESC>F002+001<ESC>XM1001
<ESC>Q50
<ESC>Z
```

2. It is necessary to specify the print position for each sequential field on a label.
3. Up to eight different sequential fields can be specified per label.
4. This command ignores alpha characters in the sequential number field.
5. This command cannot be used with the following commands:
 - Copy Image, Page 4-33
 - Reverse Image, Page 4-68
 - Line Feed, Page 4-52

Start/Stop Label

Command Structure

Start Command <ESC>A

Stop Command <ESC>Z

Example: See above

Placement: <ESC>A must precede data

<ESC>Z must follow data

Default: None

Command Function

For all print jobs, the Start command must precede the data, and the Stop command must follow. The print job will not run properly if these are not in place.

Printer Input

<ESC>A

<ESC>H0001<ESC>V0100<ESC>WB1SATO

<ESC>H0130<ESC>V0200<ESC>B103150*M-5900RV*

<ESC>H0170<ESC>V0360<ESC>L0202<ESC>S*M-5900RV*

<ESC>Q1<ESC>Z

Printer Output

There is no output for these commands that are not accompanied by other label printing commands. However these commands must precede and follow each print job sent to the printer.

Calendar Increment

This command requires the Calendar option.

Command Structure

<ESC>WPabbb

a = Y Years

M Months

D Days

h Hours

bbb = Numeric data: Years (1-9), Months (01-99)
Weeks (01-99), Days (001-999), Hours (001-999)

Example: <ESC>WPM03

Placement: Anywhere within the data stream

Default: None

Command Function

To add a value to the printers's current date and/or time which may then be printed on the label. This command does not change the printer's internal clock setting.

Printer Input

<ESC>A

<ESC>H0100<ESC>V100<ESC>XB1Current Date:

<ESC>WAMM/DD/YY

<ESC> **WPM06**

<ESC>H0100<ESC>V0200<ESC>XB1Expiration Date:

<ESC>WAMM/DD/YY

<ESC> Q1<ESC>Z

Printer Output

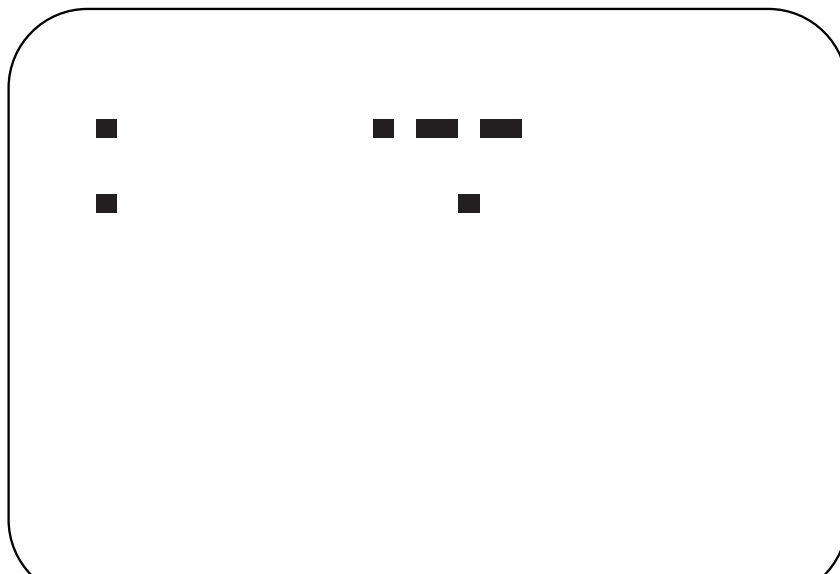

Calendar Increment

Special Notes

1. This command requires the Calendar Option. See your SATO representative for more details.
2. Once the year increments past "99" it will wrap back to "00".
3. This command can only be used once per data stream.
4. The printer's internal clock may be set through the Calendar Set command (see Page 4-81).
5. If a print quantity of more than one label per job is used, the same item and date will be on each label of the entire print job.
6. Calendar Increment Example:
1999 January 15 (ww=03) plus 48 weeks = week 51
7. The Week Calendar specification follows ISO8601. Days of the week are numbered 1 thru 7 beginning with Monday. The first week of the year is the week containing the first Thursday. If January 1st falls on Friday it belongs to the last week of the previous year. If December 31st falls on a Wednesday it belongs to the first week of the following year. If Calendar increment calculation extends over the year, the result belongs to the week number of the following year.

Calendar Print

This command requires the Calendar option.

Command Structure

<ESC>WA(elements)

(elements) = YYYY 4 digit Year (1981-2080)
 YY 2 digit Year (00-91)
 MM Month (01-12)
 DD Day (01-31)
 HH 12 Hour Clock (00-11)
 hh 24 Hour Clock (00-23)
 mm Minute (00-59)
 ss Seconds (00-59)
 TT AM or PM
 JJJ Julian Date (001-366)
 WW Week (00-53)
 ww Week (01-54)

Example: **<ESC>WAMM/DD/YY**

Placement: Anywhere within the data stream

Default: None

Command Function

To Specify the printing of a date and/or time field from the printer's internal clock. This may be used to date/time stamp your labels.

Printer Input

```
<ESC>A
<ESC>H0100<ESC>V100<ESC>XB1The current date is:
<ESC>XB1<ESC>WAMM/DD/YY
<ESC> WPM06
<ESC>H0100<ESC>V0200<ESC>XB1The current time is:
<ESC>XB1<ESC>WAhh:mm
<ESC> Q1<ESC>Z
```

Printer Output

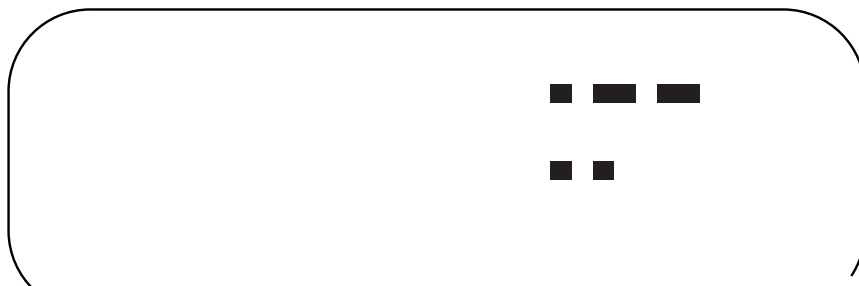

Calendar Print

Special Notes

1. This command requires the Calendar Option. See your SATO representative for more details.
2. The date and time elements may be placed in any order for printing.
3. Use a slash (/) to separate date elements and a colon (:) to separate time elements.
4. The font for the date/time elements must be specified before this command.
5. The printer's internal clock may be set through the Calendar Set command (see Page 4-81).
6. This command can be used up to six times per job.
7. The Copy (<ESC>WD), Mirror Image (<ESC>RM) or Reverse Image (<ESC>/) commands cannot be used with this command.
8. Up to 16 characters can be used with this command.
9. Century Ranges are:
For Year + YY, any year equal to or greater than 80 and less or equal to 99, then the century equals 19. For any year equal to or greater than 100, then the century equals 20.
10. The Julian date is the accumulated day from January 1st to the current date. The first day of the year is January 1st (001) and the last day of the year is December 31st (365 or 366 for leap years).
11. The TT command parameter should not be specified for printing in numeric only bar codes.
12. The Week Calendar specification follows ISO8601. Days of the week are numbered 1 thru 7 beginning with Monday. The first week of the year is the week containing the first Thursday. If January 1st falls on Friday, it belongs to the last week of the previous year. If December 31st falls on a Wednesday it belongs to the first week of the following year. If Calendar Increment calculation extends over the year, the result belongs to the week number of the following year.
13. All time and date rules conform to the ISO8601 specification.

Calendar Set

Command Structure

<ESC>WTaabbccdde

aa = Year (01-99)
bb = Month (01-12)
cc = Day (01-31)
dd = Hour (00-23)
ee = Minute (00-59)

Example: <ESC>WT9101311200

Placement: This command must be sent in an independent data stream.

Default: None

Command Function

To set the time and date of the printer's internal clock

.

Printer Input

<ESC>A
<ESC>WT9312251300
<ESC> Z

Printer Output

There is no printer output for this command. It sets the current date to December 25, 1993 and the current time to 1:00 PM in the printer.

Special Notes

This command requires the Calendar Option. See your SATO representative for more details.

Memory Card Function

Clear Card Memory

Command Structure

<ESC>*a,bb

a = Memory card section to be cleared

G To clear SATO graphics files from memory card

P To clear PCX graphics files

F To clear formats from the memory card

O To clear TrueType fonts

bb = Memory Card storage area to be cleared

01 to 99 for Graphics, PCX or Formats

00 to 99 for TrueType fonts

Example: <ESC>***G,01**

Placement: This command should be sent to the printer immediately following the <ESC>CC Slot Select command.

Default: None

Command Function

To clear individual memory areas in the Memory Card.

Printer Input

<ESC>A

<ESC>CC1<ESC>***O,09**

<ESC> Z

Printer Output

There is no printer output as a result of his command.

Special Notes

1. To clear everything in the memory card, use the <ESC>BJF Memory Card Initialize command (see Page 4-94).
2. This command is ignored if there is no data to be cleared.
3. This command is ignored if a memory card is not installed in the printer.

Memory Card Function

Expand Memory Area

This command requires the Memory Card option.

Command Structure

<ESC>EXa

a = Memory Designation
0 Use Printer Memory
1 Use Memory Card Slot 1
2 Use Memory Card Slot 2

Example: <ESC>EX1

Placement: In its own data stream immediately after powering on.

Default: None

Command Function

This command expands the memory available to image labels by using the Memory Card.

Printer Input

<ESC>A
<ESC>EX2
<ESC>Z

Printer Output

There is no printer output as a result of this command.

Special Notes

1. You must have the optional Memory Card to use this command. Call your local SATO representative for details.
2. When the printer is turned off, the Memory Card is reset to normal operation.
3. If the Memory Card specified already contains data, it cannot be used for memory expansion.
4. The printer will reserve the specified Memory Card for expanded memory until it is turned off or receives another <ESC>EX Expand Memory Area command.
5. Use care with Line and Box commands as excessively long lines can damage the print head.
6. The maximum vertical position that can be specified by the <ESC>V vertical position command is shown in the following table.

Memory Card Function

Expand Memory Area

M-5900RV	
Standard Print Length	1424 dots 7.0 in. 178 mm
Expanded with <ESC>AX Command	2848 dots 14.0 in. 356 mm
Maximum Length with Memory Card ⁽²⁾	
128 Kbyte	1257 dots 6.2 in. 157 mm
512 Kbyte	5038 dots 24.8 in. 629 mm
1 Mbyte	9999 dots ⁽¹⁾ 49.2 in. 1249 mm
2 Mbyte	9999 dots ⁽¹⁾ 49.2 in. 1249 mm

(1) Limited by the number of digits in the command field.

(2) When a Memory Card is used to expand the print length the card capacity is used instead of the internal memory not in addition to the internal memory.

Special Notes (Cont.)

7. If a job contains elements out of the memory range it is ignored.
8. This command cannot be used with the <ESC>AX and <ESC>AR Expanded Print Length commands, or the <ESC>R Rotate, Moving Base Reference Point command.
9. If the Forms Overlay command <ESC>& is used with a Memory Card to expand the print area, the Form Overlay length is still limited to 14".

Memory Card Function Fonts, TrueType Recall

This command requires the Memory Card option.

Command Structure

```
<ESC>BJRabbccddeeeff...f
<ESC>BJTaa,bb,cc,dd,ee,ffff,gggg
```

aa = Font ID (0 thru 9 or 00 thru 99)
 bb = Horizontal Expansion (01 thru 12)
 cc = Vertical Expansion (01 thru 12)
 dd = Character Pitch (01 thru 99)
 ee = Always 00
 ffff = Number of characters to be printed using the font
 g..gg = Data to be printed

Example: **<ESC>BJR1020201000004SATO**

Placement: Immediately following the <ESC>CC Slot Select command.

Default: None

Command Function

This command recalls previously stored TrueType fonts from a Memory Card.

Printer Input

```
<ESC>A
<ESC>V0100<ESC>H0100<ESC>CC1<ESC>BJR1020201000004SATO
<ESC> Q1<ESC> Z
```

Printer Output



Special Notes

This command requires the Memory Card Option. See your SATO representative for more details.

Memory Card Function Fonts, TrueType Store

This command requires the Memory Card option.

Command Structure

Begin Download <ESC>**BJ**(aa...abb..b
Download <ESC>**BJD**ccccccddddee...e
End Download <ESC>**BJ**)

aa..a = 40 byte font description
bb..b = 10 byte date information
cccc = Memory offset (hexadecimal)
dddd = Number of data bytes to be stored (0001-2000)
ee...ee= Font data to be downloaded

Example: <ESC>**BJ**{50 byte header}
<ESC>**BJD**{5 byte hex memory offset}{data}
<ESC>**BJ**)

Placement: Immediately following the <ESC>CC Slot Select command.

Default: None

Command Function

This command allows TrueType fonts to be stored in a Memory Card.

Printer Input

The download data stream is very complex and it is recommended that the TrueType Download utility program be used instead of manually creating the required command and data stream.

Printer Output

There is no printer output as a result of this command. See <ESC>BJR TrueType Font Recall command.

Special Notes

1. This command requires the Memory Card option. See your SATO representative for details.
2. The SATO TrueType Download utility program can be used to automate the download process from a computer running Windows 3.1 or above. A copy of this utility program is included as a part of the Memory Card Option.

Memory Card Function

Format/Field Recall

This command requires the Memory Card option.

Command Structure

<ESC>YR,aa<ESC>/D,bb,cc...c

aa = Format number to be recalled (01-99)
 bb = Field number to be recalled (01-99)
 cc...c = Data to be placed in recalled field

Example: <ESC>YR,01<ESC>/D,01,99

Placement: Immediately following the <ESC>CC Slot Select command.

Default: None

Command Function

To recall a field from a stored format and place new data in the field.

Printer Input

<ESC>A
 <ESC>CC1
 <ESC>YR,02<ESC>/D,01,TWO FIELDS OF<ESC>/D,02,VARIABLE DATA
 <ESC>Q1<ESC>Z

Printer Output



**TWO FIELDS OF
 VARIABLE DATA**

Special Notes

1. This command requires the Memory Card Option. See your SATO representative for details.
2. Only one format can be recalled at a time. However multiple fields may be recalled from the same format.
3. The number of data characters contained in the "cc...c" field cannot exceed the value designated in the <ESC>/N Field Store command. If it does, the data will be truncated to fit the field length defined in the Field Store Command.

Memory Card Function

Format/Field Store

This command requires the Memory Card option.

Command Structure

<ESC>YS,aa<ESC>/N,bb,cc{.....}

aa = Format number to be stored (01-99)

bb = Field number to be stored (01-99)

cc = Length of field to be stored (01-99)

{.....}= Command stream describing the field to be stored.

Example: <ESC>YS,01<ESC>/N,01,05

Placement: Immediately after <ESC>CC Slot Select command.

Default: None

Command Function

To store a format field description in the memory card.

Printer Input

<ESC>A

<ESC>CC1

<ESC>YS,02<ESC>/N,01,13<ESC>V0100<ESC>H0100<ESC>XB1

<ESC>/N,02,13<ESC>V0200<ESC>H0200<ESC>XB1

<ESC> Z

Printer Output

There is no printer output for this command. See <ESC>YR Format/Field Recall command.

Special Notes

1. This command requires the Memory Card option. See your SATO representative for details.
2. Each job should be sent individually. If more than one job is sent in a data stream, only the first one will be accepted and the remainder ignored.
3. The following commands cannot be stored in a format:

<ESC>CS	Print Speed	<ESC>C	Repeat Label
<ESC>NULL	Cut Label	<ESC>Q	Print Quantity
<ESC>/D	Recall Field	<ESC>EX	Expanded Label Storage
<ESC>T	Custom Characters	<ESC>&	Store Form Overlay
<ESC>@	Off Line	<ESC>#E	Print Darkness
<ESC>BJ	TrueType Fonts	<ESC>ID	Store Job ID
<ESC>G	Store Custom Graphics	<ESC>*	Clear Memory & Buffer
<ESC>BT	Variable Ratio Bar Codes	<ESC>PI	Store PCX Graphics
<ESC>0	Partial Edit		

Memory Card Function

Graphics, Custom Recall

This command requires the Memory Card option.

Command Structure

<ESC>**GR**aaa

aaa = Graphics storage number (001-999)

Example: <ESC>**GR111**

Placement: The Recall command is sent in a secondary data stream to print the graphic, and follows any necessary position or size commands.

Default: None

Command Function

Use the Recall command any time you want to print a graphic image on a label along with other printed data.

Printer Input

Non Rotated Graphic

```
<ESC>A<ESC>CC1
<ESC>V0100<ESC>H0080<ESC>L0505
<ESC>GR001
<ESC>Q1<ESC>Z
```

Graphic Rotated 90°

```
<ESC>A<ESC>CC1<ESC>%1
<ESC>V0180<ESC>H0250<ESC>L0505
<ESC>GR001
<ESC>Q1<ESC>Z
```

Graphic Rotated 180°

```
<ESC>A<ESC>CC1<ESC>%2
<ESC>V0180<ESC>H0500<ESC>L0505
<ESC>GR001
<ESC>Q1<ESC>Z
```

Graphic Rotated 270°

```
<ESC>A<ESC>CC1<ESC>%3
<ESC>V0100<ESC>H0700<ESC>L0505
<ESC>GR001
<ESC>Q1<ESC>Z
```

Printer Output

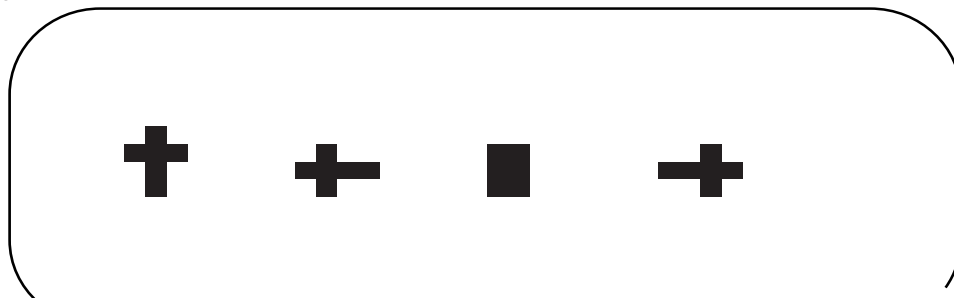
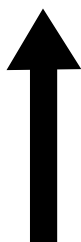

Special Notes

1. This graphic image to be stored, cannot be rotated before it is stored. It can be rotated when it is recalled.
2. Graphic images cannot be stored as part of a label format.
3. See the <ESC>GI Custom Graphic Store command Page 4-90.

Memory Card Function Graphics, Custom Store

This command requires the Memory Card option.

Command Structure

<ESC>Glabbbccddd{data}
a = Specifies character format of the data
 H Hex data
 B Binary data
bbb = Number of horizontal 8 x 8 blocks (001-248)
ccc = Number of vertical 8 x 8 blocks (001 -267)
ddd = Graphics storage number (001-999)
{data} = Hex or binary data to describe the graphic Image

Example: See Appendix C for detailed information on creating Hex and Binary graphic files.

Placement: Immediately following the <ESC>CC Slot Select command.

Default: None

Command Function

To provide similar functionality to the <ESC>G Custom Graphic command (see Page 4-45), but allows for the graphic image to be stored in a Memory Card. Use the Store command to send the graphic data to the printer, which is held in the optional memory card even if printer power is lost.

Printer Input

<ESC>A
<ESC>CC1<ESC>GIH002002001
0100038007C00FE01FF03FF87FFCFFFE07C007C007C007C007C007C007C007C007C0
<ESC> Z

Note: See Appendix C for detailed explanation on how to format a graphics data stream.

Printer Output

There is no printer output for this command. See <ESC>GR Recall Custom Graphics command.

Memory Card Function Graphics, Custom Store

Special Notes

1. This command requires the Memory Card option. See your SATO representative for details.
2. The maximum storage capacity is 999 graphics, up to the capacity of the memory card used.
3. If a data transmission error occurs, the printer will beep and the "ERROR" LED will come on. You must then retransmit the image. See Appendix D for information on Memory Card error reporting.
4. Each graphic to be stored must be sent in its own data stream.

Example of correct data stream:

```
<ESC>A  
<ESC>GIHaaabbb001(DATA)  
<ESC>Z  
<ESC>A  
<ESC>GIHaaabbb002(DATA)  
<ESC>Z
```

Example of incorrect data stream:

```
<ESC>A  
<ESC>GIHaaabbb001(DATA)  
<ESC>GIHaaabbb002(DATA)  
<ESC>Z
```

5. Do not use ASCII <CR> or <LF> characters (carriage return or line feed) as line delimiters within the graphic data or the actual image will not be printed as specified.

Memory Card Function Graphics, PCX Recall

This command requires the Memory Card option.

Command Structure

<ESC>PYaaa

aa = Storage area number (001 thru 099)

Example: <ESC>PY001

Placement: This command must be placed within its own data stream specifying the placement of the graphic.

Default: None

Command Function

To recall for printing a graphic file previously stored in a PCX format in the Memory Card.

Printer Input

Normal Rotation

<ESC>A<ESC>CC1
<ESC>V0100<ESC>H0000<ESC>PY001
<ESC>Q1<ESC>Z

Rotate Base Reference Point

<ESC>A<ESC>CC1<ESC>%1
<ESC>V0330<ESC>H0180<ESC>PY001
<ESC>Q1<ESC>Z

2nd Rotation, Base Reference Point

<ESC>A<ESC>CC1<ESC>%2
<ESC>V0330<ESC>H0600<ESC>PY001
<ESC>Q1<ESC>Z

3rd Rotation, Base Reference Point

<ESC>A<ESC>CC1<ESC>%3
<ESC>V0100<ESC>H0800<ESC>PY001
<ESC>Q1<ESC>Z

Printer Output

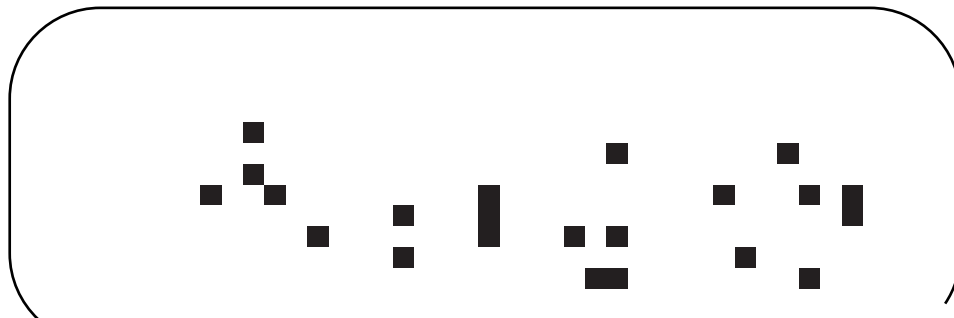
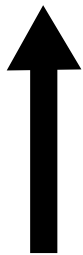

Special Notes

1. This command requires the Memory Card option. See your SATO representative for details.
2. See the <ESC>PI Store PCX Graphics command.

Memory Card Function

Graphics, PCX Store

This command requires the Memory Card option.

Command Structure

<ESC>PIaaa,bbbb,{data}

aaa = Storage area number (001 thru 999)
 bbbbb = Size of PCX file in bytes
 {data} = Data

Example: **<ESC>PI001,32000,{data}**

Placement: This command must be placed within its own data stream.

Default: None

Command Function

To store for later printing a PCX graphic file in the Memory Card.

Printer Input

BASIC Program to Download a PCX file to Memory Card #1, Location #1

```
OPEN "C:\WIZARD\GRAPHICS\LION.PCX"FOR INPUT AS #2
DA$=INPUT$(3800,#2)
C$=CHR$(27)
WIDTH"LPT1:",255
LPRINTC$;"A";C$;"CC1"
LPRINTC$;"PI001,03800,";DA$
LPRINTC$;"Z"
CLOSE #2
```

Printer Output

There is no printer output for this command. See <ESC>PY PCX Graphics Recall command.

Special Notes

1. This command requires the Memory Card option. See your SATO representative for details.
2. Graphics cannot be stored as part of a format
3. Only black and white PCX files can be stored.
4. The file size specified by this command is the DOS file size in bytes.

Memory Card Function Initialize

This command requires the Memory Card option.

Command Structure

<ESC>BJFaaaaaaa

aaaaaa = Eight character alphanumeric user ID

Example: <ESC>BJFsatocard

Placement: Immediately following the <ESC>CC Slot Select command

Default: None

Command Function

This clears all of the data from the Memory Card in the specified slot and prepares the card to accept data.

Input to Printer

<ESC>A

<ESC>CC2<ESC>BJFsatocard

<ESC> Z

Printer Output

There is no printer output for this command.

Special Notes

1. This command requires the Memory Card option. See your SATO representative for details.
2. All Memory Cards must be initialized before they can be used for the first time.
3. Care should be exercised when using this command as it destroys any data previously written to the card. It will clear all data from the card and assign the new ID ("satocard" in the above example).

Memory Card Function Slot Select

This command requires the Memory Card option.

Command Structure

<ESC>**CCa**

a = Memory Card Slot
1 Slot 1
2 Slot 2

Example: <ESC>**CC1**

Placement: Immediately following the <ESC>A Start Code.

Default: Last selected Memory Card Slot.

Command Function

Selects the card slot to be used for following Memory Card commands

Input to Printer

<ESC>A

<ESC>CC1

(commands)

<ESC> Z

Printer Output

There is no printer output for this command.

Special Notes

This command requires the Memory Card option. See your SATO representative for details.

Memory Card Function Status

This command requires the Memory Card option.

Command Structure

<ESC>BJS

Example: <ESC>BJS

Placement: After the <ESC>CC Slot Select command.

Default: None

Command Function

Causes the printer to print the card status

Printer Input

<ESC>A

<ESC>CC1<ESC>BJS

<ESC> Z

Printer Output

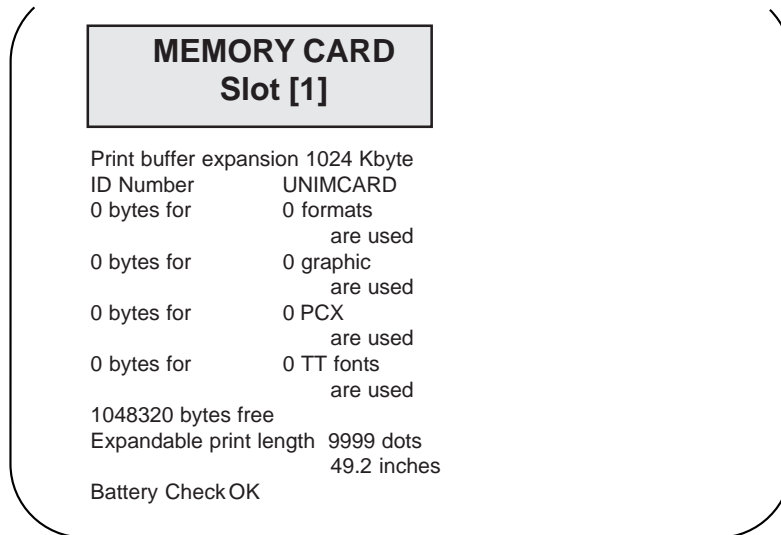

Special Notes

1. This command requires the Memory Card option. See your SATO representative for details.
2. The following information is provided on the status label:
Line 1: Memory size of the card in Kbytes
Line 2: The ID number assigned with the <ESC>BJF command
Line 3: Number of fomats stored and bytes used
Line 4: Number of graphics stored and bytes used
Line 5: Number of PCX files and bytes used
Line 6: Number of TT fonts stored and bytes used
Line 7: Remaining free memeory
Line 8: Max expandable print length using the card
Line 9: Battery check results

Custom Protocol Command Codes Download

Command Structure

<ESC>LD,a,b,c,d,e,f,g,h.,i

- a = Replacement character for STX in ASCII or hex format
- b = Replacement character for ETX in ASCII or hex format
- c = Replacement character for ESC in ASCII or hex format
- d = Replacement character for ENQ in ASCII or hex format
- e = Replacement character for CAN in ASCII or hex format
- f = Replacement character for NULL in ASCII or hex format
- g = Replacement character for OFFLINE in ASCII or hex format
- h = Auto-Online. Printer powers up in the Online mode.
0 = Yes
1 = No
- i = Zero Slash. Places a slash through the "0" character.
0 = Yes
1 = No

Example: <ESC>LD,{,},%,#,&*,~,0,0

Placement: Immediately following the <ESC>A Start command and in an independent data stream.

Default: Standard Protocol command codes

Command Function

Allows the user to define Custom Protocol command codes

Printer Input

<ESC>A

<ESC>LD,{,},%,#,&*,~,0,0

<ESC> Z

Printer Output

A Protocol Command code status label will be printed as a result of a successful download of a custom set of Protocol Command codes.

(Next Page)

Custom Protocol Command Codes Download

Printer Output (Cont)



```
STX = 7B      ETX = 7D      ESC = 25
ENQ = 23      CAN = 26      NULL = 2A
OFFLINE = 7E
AUTO ONLINE =      YES
ZERO SLASH =      YES
```

Press the "FEED" key to activate
the User Default or power the
printer off to ignore them.

Special Notes

1. Commas must be used to separate the parameters. If a parameter is omitted between two commas, the default Non-Standard Protocol Command codes for that parameter will be used. See Appendix E.
2. This command must be sent as an independent data stream immediately following the <ESC>A Start code and immediately preceding the <ESC>Z Stop code. No other commands can be included in the data stream.
3. If more or less than nine commas are included in the command, the entire command sequence will be ignored. The command must contain exactly nine commas.
4. If two characters are specified for a parameter, it will be interpreted as a hex value. For example:

Command Parameter	Resulting Command Code
2B	+
+	+

If a combination of characters are outside the hexadecimal range, the entire command sequence will be ignored.

5. Downloading Auto Online and Zero Slash settings will overwrite the values selected using the LCD panel. If these settings are changed using the LCD panel, they will overwrite any previously downloaded settings.

Two-Dimensional Bar Codes

Data Matrix, Data Format

Command Structure

<ESC>BXaabbccddeeffghh

aa	=	Format ID, 01-06 or 11-16. The values 07 and 17 will not be accepted by the printer.
bb	=	Error correction level, 00, 01, 04-14 or 20. All other values will be processed as a 00.
cc	=	Horizontal cell size, 03-12 dots/cell.
dd	=	Vertical cell size, 03-12 dots/cell.
eee	=	Number of cells in one line. Must use 000 to optimize.
fff	=	Number of cell lines. Must use 000 to optimize.
g	=	Mirror Image 0 = Normal Print 1 = Reverse Print
hh	=	Guide Cell Thickness, 01-15. 01 indicates normal type.

Example: <ESC>BX03080505000000001

Placement: Immediately preceding data to be encoded

Default: None

Command Function

To designate the format for a Data Matrix two-dimensional bar code image on a label.

Printer Input

```
<ESC>A
<ESC>%0<ESC>V0100<ESC>H0100<ESC>BX05051010000000001
<ESC> DCDATA MATRIX DATA MATRIX
<ESC> Q1<ESC> Z
```

Printer Output

There is no printer output for this command. See <ESC>DC Print Data command for printer output.

Special Notes

1. If any of the parameters entered are outside the valid range, a symbol will not be printed when the <ESC>DC Print Data command is sent to the printer.
2. The number of cells per line (eee) and the number of cell lines (fff) should be specified as all zeroes, allowing the printer to automatically calculate the optimum configuration for the symbol.
3. The Reference Point for the Data Matrix symbol is the upper-left corner. If an <ESC>R Rotate command is used to rotate the symbol, it will rotate in the counter-clockwise direction.
4. The Format ID specified for "aa" is defined by the following table. The printer only supports the Format IDs defined in the table.

Two-Dimensional Bar Codes

Data Matrix, Data Format

ECC Level (bb)	Format ID (aa)					
	01	02	03	04	05	06
00 (ECC000)	500	452	394	413	310	271
05 (ECC050)	457	333	291	305	228	200
08 (ECC080)	402	293	256	268	201	176
10 (ECC100)	300	218	190	200	150	131
14 (ECC140)	144	105	91	96	72	83
20 (ECC200)	Numeric				3116	
	Alphanumeric				2336	
	ISO 8 bit (01 _H - FF _H)				1556	

5. The character set or each Format ID is:

Two-Dimensional Bar Codes

Data Matrix, Print Data

This command is used to create two-dimensional symbologies supported by M-5900RV printers

Command Structure

<ESC>DCxx...x

xx...x = Data, maximum of 500 characters

Example: <ESC>DC00006000

Placement: Immediately following the <ESC>BC Data Format designation command or the <ESC>FX Sequential Numbering command

Default: None

Command Function

To print a Data Matrix two-dimensional bar code image on a label.

Printer Input

```
<ESC>A
<ESC>%0<ESC>V0100<ESC>H0100<ESC>BX05051010000000001
<ESC> DCDATA MATRIX DATA MATRIX
<ESC> Q1<ESC> Z
```

Printer Output



Special Notes

1. The maximum amount of data that can be printed with this command is 500 characters.
2. If an <ESC>BX Data Format designation command contains any parameters out of the valid range, no symbol will be printed when this command is sent.

Two-Dimensional Bar Codes

Data Matrix, Sequential Numbering

This command is used to create two-dimensional symbologies supported by M-5900RV printers

Command Structure

`<ESC>FXaaabcccdddeee`

aaa = Number of duplicate labels to be printed (001-999).

b = Increment or Decrement

+ = Increment

- = Decrement

ccc = Increment/Decrement Steps (001-999)

ddd = Sequential numbering start position (001-999)

Referenced to left side.

eee = Incremented data length measured from start position (001-999).

Placement: Immediately following the `<ESC>BX` Data Format designation command and preceding the `<ESC>DC` Print Data command.

Default: None

Command Function

To print sequential numbered Data Matrix symbols.

Printer Input

`<ESC>A`

`<ESC>V0100<ESC>H0100`

`<ESC>BX03081010000000001`

`<ESC>FX002+001005003<ESC>DC000060000`

`<ESC> Q4<ESC> Z`

Printer Output

Label Set #1

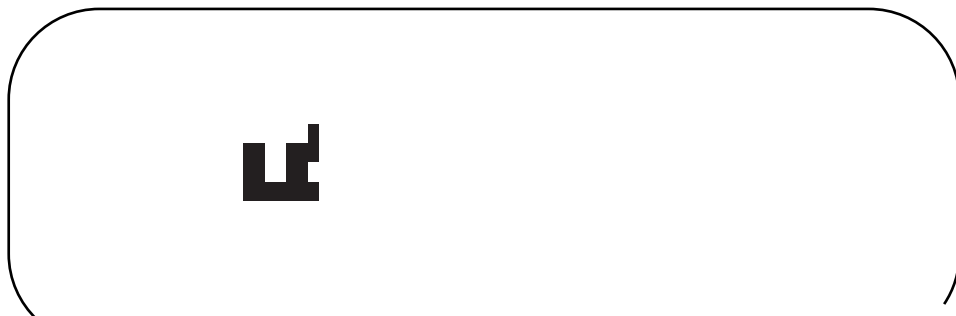
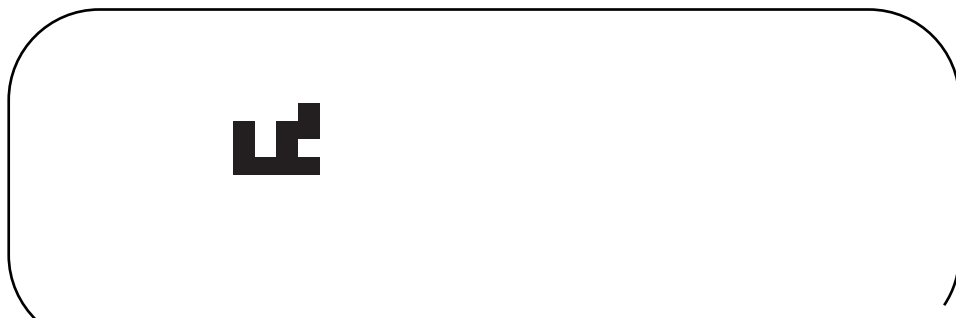

Two-Dimensional Bar Codes

Data Matrix, Sequential Numbering

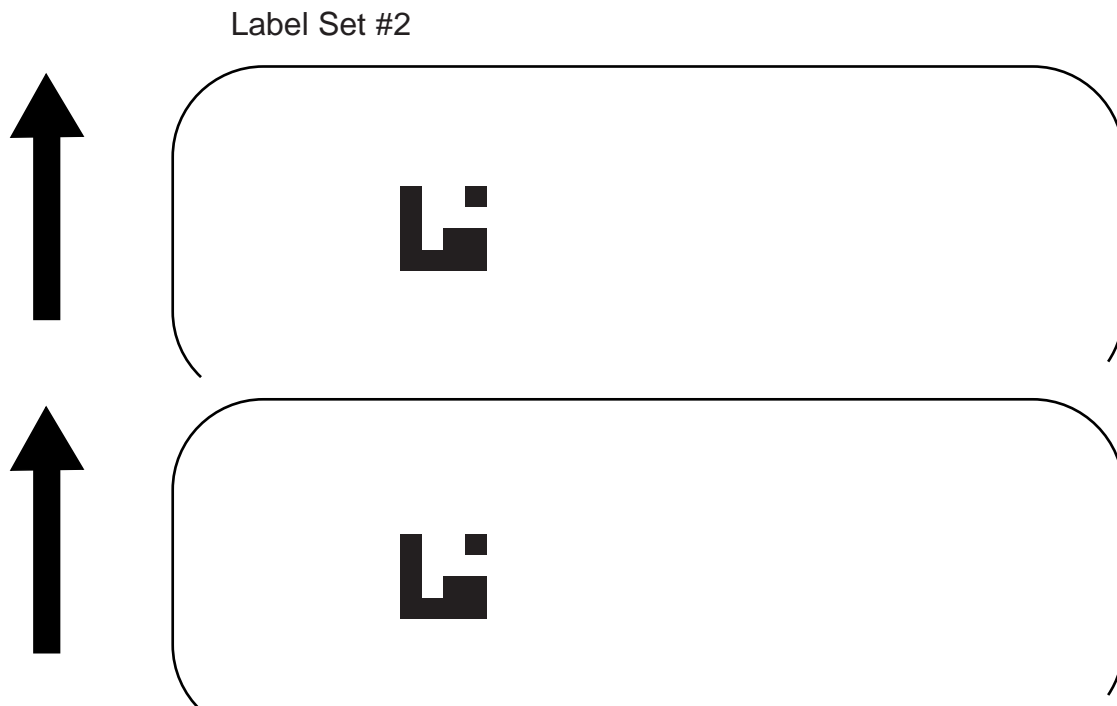

Special Notes

1. The maximum number of <ESC>FX Sequential Numbering commands that can be used in one job is eight.
2. In the example above, four total labels will be printed. (<ESC>FX002+005003<ESC>DC00006000). The sequential numbering will start at position 5 and the three digits "600" will be incremented in steps of 1. A total of two sets of labels will be printed, the first set of two labels with the value "00006000" and the next two label set with the value "00006010".

Label Set #1		Label Set #2	
1st Label	00006000	3rd Label	00006010
2nd Label	00006000	4th Label	00006010

3. The <ESC>Q Label Quantity command must be set for the total number of labels to be printed. In the above example, the value for the <ESC>Q command should be 2 sets x 2 labels/set = 4. If, in the above example it was set to a value of "1", only the first label would be printed.

Two-Dimensional Bar Codes

Maxicode

This command is used to create two-dimensional symbologies supported by M-5900RV printers

Command Structure

<ESC>BVa,b,c,ddddddddd,eee,fff,gggg...<ESC>

- | | | |
|----------|---|--|
| a | = | Position of Maxicode symbol within the set, when used in a structured append format 1-8. |
| b | = | Total number of Maxicode symbols in the set, when used in a structured format 1-8. |
| c | = | 2 For Mode 2 Structured Carrier Message for Domestic U.S. UPS shipments.
3 For Mode 3 Structured Carrier Message for International UPS shipments.
4 Standard symbol
5 Not currently supported
6 Reader programming |
| ddd..ddd | | 9 digit numeric Postal Code |
| eee | = | 3 digit numeric Country Code |
| fff | = | 3 digit numeric Service Code |
| gg..g | = | Data, terminated by <ESC> |

Example: <ESC>BV1,2,3,123456789,222,333,MESSAGE<ESC>

Placement: Immediately preceding data to be encoded

Default: None

Command Function

To print a Maxicode two-dimensional bar code image on a label. See Appendix B for specific information on using each individual bar code symbol.

Command Function

To print a UPS Maxicode symbol.

Input to Printer

```
<ESC>A<ESC>V0100<ESC>H0100
<ESC>BV1,1,2,123456789,840,001,]<RS>01<GS>961Z01547089<GS>UPSN
<GS>056872<GS>349<GS>99999999<GS>001/005<GS>029<GS>N<GS>
<GS>LENEXA<GS>KS<RS><EOT>
<ESC> Q001<ESC> Z
```

Two-Dimensional Bar Codes

Maxicode

Printer Output



Special Notes

1. The Secondary Message field (ee...e) must contain exactly 84 characters. If a smaller message is specified, the field must be padded with "exclamation point" character(s).
2. <Rs> represents Hex 1E, <Gs> represents Hex 1D, <Eot> represents Hex 04, <ESC> represents Hex 1B and <Sp> represents Hex 20.

Two-Dimensional Bar Codes

PDF417

This command is used to create two-dimensional symbologies supported by M-5900RV printers

Command Structure

<ESC>**BK**aabbcddeefffn...n

- aa = Minimum module dimension (03-09 dots). Will not print if values of 01, 02 or greater than 10 are specified.
- bb = Minimum module pitch dimension (04-24 dots). Will not print if values of 01, 02, 03 or greater than 25 are specified.
- c = Security (error detection) Level (1-8).
- dd = Code words per line (01-30). If 00 is specified for both dd and ee the printer automatically optimizes the number of rows per symbol.
- ee = Rows per symbol (00 or 03-40). If 00 is specified for both dd and ee the printer automatically optimizes the number of rows per symbol.
- fff = Number of characters to be encoded (0001-2700).
- nn...n = Data to be printed.

Example: <ESC>**BK0304400000021**

Placement: Immediately preceding data to be encoded

Default: None

Command Function

To print a PDF417 two-dimensional bar code image on a label.

Printer Input

<ESC>A

<ESC>V0100<ESC>H0100,<ESC>**BK0607400000021PDF417PDF417PDF417**

<ESC> Q1<ESC> Z

Two-Dimensional Bar Codes

PDF417

Printer Output



Special Notes

1. When the code words per line and the number of rows per symbol ("dd" and "ee") are set to all zeroes, the printer will calculate the optimum configuration.
2. If the product of the values entered for "dd" and "ee" are not equal to or less than the value of "fff" (i.e., "fff" is greater than "dd" x "ee"), an error will occur and the symbol will not be printed. It is recommended that these values each be set to "000" and the printer be allowed to automatically calculate the optimum values.
3. The values for "dd" and "ee" need to be made larger if the security level is increased.
4. The maximum data length is 2700 characters, but may be less depending upon:
 - the minimum module dimension ("aa")
 - the security level specified by "c"
 - the number of data characters
5. The Reference Point of the PDF417 symbol is the upper-left corner.
6. The <ESC>F Sequential numbering command cannot be used with this command.
7. The <ESC>E Line Feed command cannot be used with this command.
8. The Macro and Truncated PDG417 symbols are not supported.
9. The values 00_H thru 1F_H can be specified as print data.
10. This command can be stored in a format.
11. The <ESC>R Rotate command can be used.
12. The print height of the symbol will vary depending upon the data specified, numeric only, alpha only, or alphanumeric.



Interface Specifications

5.1 Introduction

This section presents the interface specifications for the M-5900RV printer. These specifications include detailed information on how to properly interface your printer with your host system.

- Interface Types
 - RS232C Serial
 - Centronics Parallel
 - Universal Serial Bus
 - Ethernet
 - Twinax/Coax
 - Accessory (EXT) Connector
- The Receive Buffer
- RS232C Serial Interface
 - General Specifications
 - Electrical Specifications
 - Pin Assignments
 - Ready/Busy Flow Control
 - X-On/X-Off Flow Control
 - Bi-Directional Communications Protocol

5.2 Interface Types

In order to provide flexibility in communicating with a variety of host computer systems all M-5900RV printers can be furnished with plug-in interface modules that meet your requirements.

The Centronics Parallel interface will probably be the most useful in communicating with IBM PCs and compatibles. The RS232C Serial interface allows connectivity to a number of other hosts. For instructions on how to properly configure your M-5900RV printer for either of these interface types, see the Printer Configuration instructions in Section 2 of this manual.

WARNING: Never connect or disconnect interface cables (or use a switch box) with power applied to either the host or the printer. This may cause damage to the interface circuitry in the printer/host and is not covered warranty.

Interface Types



**CENTRONICS
PARALLEL INTERFACE**



**RS232C SERIAL
INTERFACE**



**USB
INTERFACE**



**ETHERNET
INTERFACE**



**TWINAX/COAX
INTERFACE**

Available Interfaces

CENTRONICS PARALLEL provides a means of communicating with IBM PCs and compatibles or anything else that supports it.

RS232C SERIAL allows connectivity to a number of other hosts.

UNIVERSAL SERIAL BUS provides Microsoft® Plug n Play specification allowing for hot-swapping.

ETHERNET provides a direct connection from the printer to all major ethernet networking systems, including Microsoft, Novell, UNIC and IBM.

TWINAX/COAX enables printers to be connected to IBM midrange and mainframe systems, such as the AS400.

5.3 The Receive Buffer

The M-5900RV printer has the ability to receive a data stream from the host in one of two ways. The receive buffer may be configured to accept one print job at a time or multiple print jobs. The single job print buffer is generally used by software programs that wish to maintain control of the job print queue so that it can move a high priority job in front of ones of lesser importance. The multiple job buffer on the other hand prints all jobs in the order they are received by the printer and the order of printing cannot be changed.

Single Job Buffer

The printer receives and prints one job at a time. Each job must not exceed 64K bytes.

Multi Job Buffer

The printer is able to continuously receive print jobs, compiling and printing other jobs at the same time. It acts much like a "print buffer" to maximize the performance of the host and the printer.

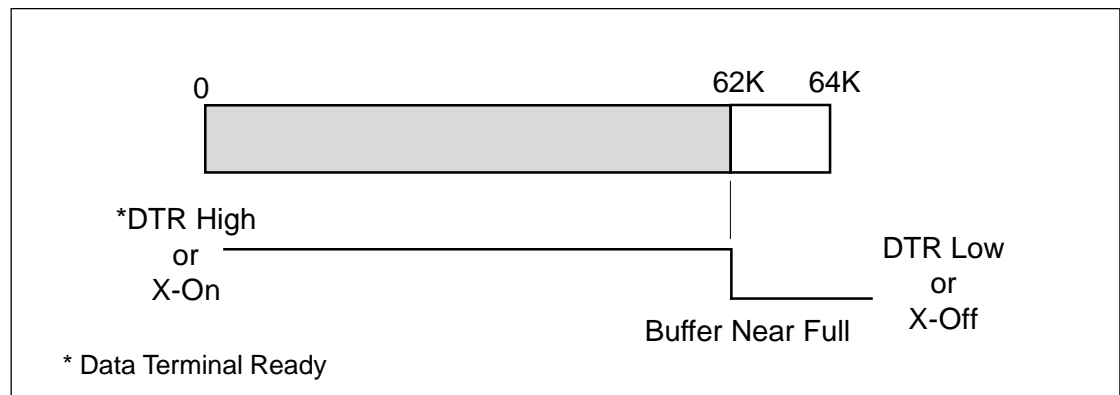

When using the RS232 Serial interface, the Multi Job Buffer uses either the **Ready/Busy** with **DTR** (pin 20) or **X-On/X-Off** flow control protocols. See these sections for more details. With an empty receiving buffer, the status of **DTR** is "high" (or an **X-On** status if using **X-On/X-Off**), meaning the printer is ready to receive data. When the receive buffer is holding 62K bytes of data (2K bytes from being full), **DTR** will go "low" (or an **X-Off** is sent) indicating the printer can no longer receive data. This condition is called "Buffer Near Full" (see figure below).

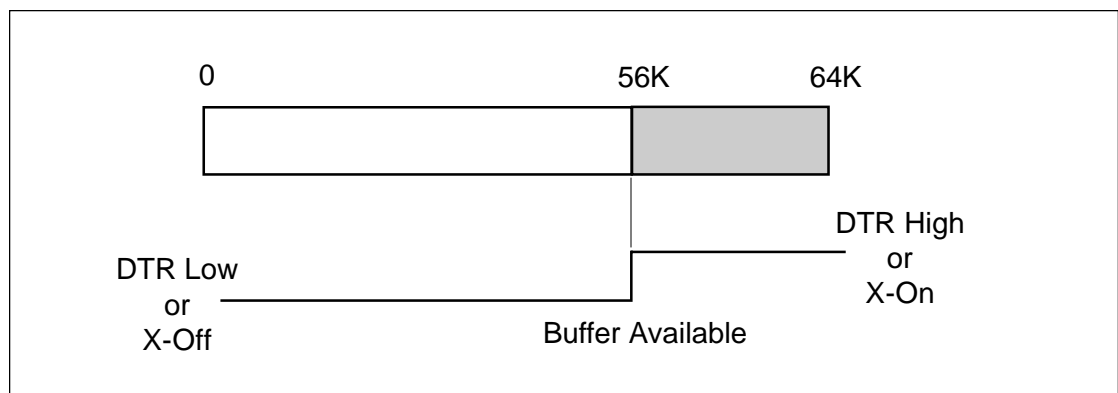

The Receive Buffer

The receiving buffer will not be able to receive more data again until a "Buffer Available" condition occurs. This takes place when the receiving buffer has emptied so that only 56K bytes of data are being held (8K bytes from being full). At this time **DTR** will go "high" or an **X-On** is sent to tell the host that it can again receive data.

All printer error conditions (i.e., label out) will cause the printer to go busy (**DTR** "low" or **X-Off**) until the problem is corrected and the printer is placed on-line. The printer will also be busy if taken off-line from the front panel.

5.4 RS232C Serial Interface

General Specifications

Asynchronous ASCII	Half-duplex communication
	Ready/Busy Hardware Flow Control Pin 20, DTR Control Pin 4, TRS Error Condition
	X-On/X-Off Software Flow Control
	Bi-Directional Communication (ENQ/Response)
Data Transmission Rate	2400, 4800, 9600 and 19200 bps
Character Format	1 Start Bit (fixed) 7 or 8 data bits (selectable) Odd, Even or No Parity (selectable) 1 or 2 Stop bits (selectable)

Electrical Specifications

Connector **DB-25S (Female)**

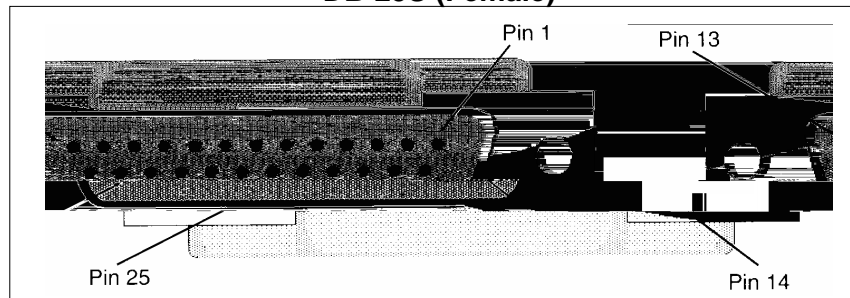

Cable DB-25P (Male), 50 ft. maximum length. For cable configuration, refer to Cable Requirements appropriate to the RS232C protocol chosen.

Signal Levels
High = +5V to + 12V
Low = -5V to -12V



Pin Assignments**RS232C Interface Signals**

PIN	DIRECTION	SIGNAL DEFINITION
1	Reference	FG (Frame Ground)
2	To Host	TD (Transmit Data) - Data from the printer to the host computer. Sends X-On/X-Off characters or status data (Bi-Directional protocol).
3	To Printer	RD (Receive Data) - Data to the printer from the host computer.
4	To Host	RTS (Request to Send) - Used with Ready/Busy flow control to indicate an error condition. RTS is high and remains high unless the print head is open (in this case, RTS would return to the high state after the print head is closed and the printer is placed back on-line) or an error condition occurs during printing (e.g. label out).
5	To Printer	CTS (Clear to Send) - When this line is high, the printer assumes that data is ready to be transmitted. The printer will not receive data when this line is low. If this line is not being used, it should be tied high (to pin 4).
6	To Printer	DSR (Data Set Ready) - When this line is high, the printer will be ready to receive data. This line must be high before data is transmitted. If this line is not being used, it should be tied high (to pin 20)
7	Reference	SG (Signal Ground)
20	To Host	DTR (Data Terminal Ready) - This signal applies to Ready/Busy flow control. The printer is ready to receive data when this pin is high. It goes low when the printer is off-line either manually or due to an error condition, and while printing in the Single Job Buffer mode. It will also go low when the data in the buffer reaches the Buffer Near Full level.

Ready/Busy/Flow Control

Ready/Busy is the hardware flow control for the serial interface on the M-5900RV printer. By raising/lowering the voltage level on Pin 20 of the RS232 port, the printer notifies the host when it is ready to receive data. Pin 4 (**RTS**) and pin 20 (**DTR**) are the important signals on the printer for this method of flow control. The host must be capable of supporting this flow control method for it to function properly.

Cable Requirements

HOST	INTERCONNECTION	PRINTER
FG	←————→	1 FG (Frame Ground)
TD	————→	3 RD (Receive Data)
		4 RTS (Request to Send)
		5 CTS (Clear to Send)
		6 DSR (Data Set Ready)
*	←————→	20 DTR (Data Terminal Ready)
SG	←————→	7 SG (Signal Ground)

* This connection at the host side of the interface would depend upon the pin that is being used as the Ready/Busy signal by the driving software. Typically on a PC it would be either CTS (pin 5) or DSR (pin 6) on a DB-25 connector.

Data Streams

Once the flow control method has been chosen for the RS232C interface, the data stream must be sent in a specific manner. The **STX** and **ETX** control characters must frame the data stream.

<STX><ESC>A..Job#1..**<ESC>Z<ETX>**<STX><ESC>A..Job#n..**<ESC>Z<ETX>**

NOTE: All characters, including STX, ESC, and ETX are in ASCII.

X-On/X-Off Flow Control

X-On/X-Off flow control must be used whenever hardware (Ready/Busy) flow control is not available or desirable. Instead of a voltage going high/low at pin 20, control characters representing "Printer Ready" (**X-On** = 11 hexadecimal) or "Printer Busy" (**X-Off** = 13 hexadecimal) are transmitted by the printer on pin 2 (Transmit Data) to the host. In order for this method of flow control to function correctly, the host must be capable of supporting it. **X-On/X-Off** operates in a manner similar to the function of pin 20 (**DTR**) as previously explained. When the printer is first powered on and goes on-line, an **X-On** is sent out. In the Single Buffer mode, when the printer receives a viable job, it transmits an **X-Off** and begins printing. When it is done printing it transmits an **X-On**. In the Multi Job Buffer mode, the printer sends an **X-Off** when the "Buffer Near Full" level is reached and a **X-On** when the data level of the buffer drops below the "Buffer Available" mark. When the printer is taken off-line manually it transmits an **X-Off** indicating it cannot accept data. When it is placed back on line manually, it sends an **X-On**, indicating it is again available for receipt of data. If an error occurs during printing (paper out), the printer sends nothing in the Single Job Buffer mode since the last character transmitted was an **X-Off**. When the error is cleared and the printer resumes printing no **X-On** is sent until the current job is completed and the printer is once again ready to receive the next job. If it is in the Multi Job Buffer mode it sends an **X-Off** as soon as an error condition detected. When the error is cleared and the printer is placed back on-line, it transmits as **X-On** indicating it is again ready to accept data.

X-On/X-Off Flow Control (Cont.)

Upon power up, if no error conditions are present, the printer will continually send **X-On** characters at five millisecond intervals until it receives a transmission from the host.

Cable Requirements

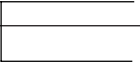
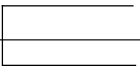
HOST	INTERCONNECTION	PRINTER
FG	←—————→	1 FG (Frame Ground)
RD	←—————	2 TD (Transmit Data)
TD	—————→	3 RD (Receive Data)
		4 RTS (Request to Send)
		5 CTS (Clear to Send)
		6 DSR (Data Set Ready)
		20 DTR (Data Terminal Ready)
SG	←—————→	7 SG (Signal Ground)

Data Streams

The data streams for **X-On/X-Off** are constructed in the same way as they are for Ready/Busy flow control. The **STX** and **ETX** control characters must frame the data stream.

NOTE: All characters, including STX, ESC, and ETX are in ASCII.

<STX><ESC>A..Job#1..<ESC>Z<ESC>A..Job#n..<ESC>Z<ETX>

Example: <STX><ESC>A..Job#1...<ESC>Z<ETX>XXXXX

Bi-Directional Communications

This is a two-way communications protocol between the host computer and the printer, thus enabling the host to check printer status. When this protocol is selected, there is no busy signal from the printer (pin 20, **DTR** is always high). The host must request the complete status from the printer, including ready/busy. Whenever the host requests printer status it transmits an **ENQ** to the printer and the printer will respond with its status within five milliseconds. If printing, it will respond upon finishing the current label, then resume printing. In order for this protocol to work properly, pin 6 (**DTR**) and pin 5 (**CTS**) must be held high by the host. One way to ensure these pins are always in the correct state is to tie pin 20 (**DTR**) to pin 6 (**DSR**) and pin 4 (**RTS**) to pin 5 (**CTS**) at the printer end of the cable.

Bi-Directional Communications (Cont)**Cable Requirements**

HOST	INTERCONNECTION	PRINTER
FG	←————→	1 FG (Frame Ground)
RD	←————	2 TD (Transmit Data)
TD	————→	3 RD (Receive Data)
	┌————	4 RTS (Request to Send)
	└————	5 CTS (Clear to Send)
	┌————	6 DSR (Data Set Ready)
	└————	20 DTR (Data Terminal Ready)
SG	←————→	7 SG (Signal Ground)

If a **CAN** (18 hexadecimal) is received by the printer, it will cancel the current print job and clear all data from the receive buffer.

Status Response

The Bi-Com protocol is an advanced version of bi-directional communications where the printer can also report the number of labels remaining to be printed for the current print job. Upon receipt of an **ENQ** command, the printer responds with nine bytes of status information bounded by an **STX** / **ETX** pair. The Bi-Com protocol works only in the Multi Job Buffer mode. The status information is defined as follows.

<STX>{2 Byte ID}{1 Status Byte}{6 Byte Label Remaining}<ETX>

ID - This is a two byte number identifying the current print job ID. The print job ID is defined using the **<ESC>ID** Job ID command transmitted with the print job (see Job ID Store in the command listing for more information on how to use this command). The range is from 00 to 99.

Status - A single byte defining the current status of the printer. (See the Status Byte Definition table on page 5-10).

Label Remaining - Six bytes defining the number of labels remaining in the current print job. The range is from 000000 to 999999 labels.

If an **ENQ** is received after the print job specified in the ID bytes has been completed, or there is no data in the buffer, the printer will respond with two "space" characters (20 hexadecimal) for the ID number and six "zero" characters (30 hexadecimal) in the Remaining Labels bytes.

Status Response

If a **CAN** (18 hexadecimal) command is received, it will stop the print job and clear all data from the receive and print buffers. A delay of five milliseconds or more is required before any new data can be downloaded. The **CAN** command is effective immediately upon receipt, even if the printer is off-line or in an error condition. The printer will return an **ACK** (06 hexadecimal) if there is no printer error condition and a **NAK** (15 hexadecimal) if an error condition exists.

Upon receipt of a valid print job (**<ESC>A...<ESC>Z**) and **ACK** (06 hexadecimal) will be returned by the printer if there are no errors and a **NAK** (16 hexadecimal) if a printer error exists.

Status Byte Definition, Bi-Com Protocol

ASCII	HEX	DEFINITION
OFF-LINE		
0	30	No Errors
2	32	Buffer Near Full
ON-LINE, WAITING FOR DATA		
A	41	No Errors
C	43	Buffer Near Full
ON-LINE, PRINTING		
G	47	No Errors
I	49	Buffer Near Full
ON-LINE, WAITING TO DISPENSE A LABEL		
M	4D	No Errors
O	4F	Buffer Near Full
ON-LINE, COMPILING PRINT JOB		
S	53	No Errors
U	55	Buffer Near Full
OFF-LINE, ERROR CONDITION		
a	61	Receive Buffer Full
b	62	Head Open
c	63	Paper End
e	65	Media Error
f	66	Sensor Error
g	67	Head Error
i	68	Memory Card Error
j	6A	Cutter Error
k	6B	Other Error Condition

5.5 Centronics Parallel Interface

Electrical Specifications

Printer Connector	AMP 57-40360 (DDK) or equivalent
Cable Connector	AMP 57-30360 (DDK) or equivalent
Cable Length	10 ft. or less
Signal Level	High = +2.4V to +5.0V Low = 0V to -0.4V

DATA STREAMS

Single Job Buffer: *The Single Job Buffer mode is not available when using the Centronics interface.*

Multi Job Buffer: <STX><ESC>A..Job#1..<ESC>Z<ETX>
<STX><ESC>A..Job#n..<ESC>Z<ETX>

Note that for parallel communications, the STX and ETX characters are not required.

Centronics Parallel Interface Pin Assignments

PIN	SIGNAL	DIRECTION	PIN	SIGNAL	DIRECTION
1	STROBE	To Printer	19	STROBE Return	Reference
2	DATA 1	To Printer	20	DATA 1 Return	Reference
3	DATA 2	To Printer	21	DATA 2 Return	Reference
4	DATA 3	To Printer	22	DATA 3 Return	Reference
5	DATA 4	To Printer	23	DATA 4 Return	Reference
6	DATA 5	To Printer	24	DATA 5 Return	Reference
7	DATA 6	To Printer	25	DATA 6 Return	Reference
8	DATA 7	To Printer	26	DATA 7 Return	Reference
9	DATA 8	To Printer	27	DATA 8 Return	Reference
10	ACK	To Host	28	ACK Return	Reference
11	BUSY	To Host	29	BUSY Return	Reference
12	PTR ERROR	To Host	30	PE Return	Reference
13	SELECT	To Host	31		
14			32	FAULT	To Host
15			33		
16			34		
17	FG	Frame Ground	35		
18	+5V (Z=24K ohm		36		

5.6 Accessory (Ext) Connector

The Accessory (or EXT) connector on the M5900RV printer is intended for use with the external printer accessories such as label rewinders or applicators. The 14 pin Centronics type connector provides a choice of four different output signals along with various error conditions.

Pin Assignments

PIN	DIRECTION	SIGNAL DEFINITION
1	To Host	Label Out - This pin goes low (0V) when a label out error exits
2	Reference	Signal Ground
3		
4	To Host	Error - This pin goes low when the printer detects an error condition such as head open or receiving buffer full.
5	To Printer	Print Start - This printer will print one label when this pin is pulled to ground. This signal must be enabled by placing switch DSW3-5 on the Control Panel in the ON position.
6	To Host	End Print - It is used to drive an applicator or other external device requiring synchronization with the print cycle. You may choose between four types of output signals using control panel DSW3-6 and DSW3-7 selections.
7	To Printer	Print Repeat - The printer repeatedly prints the current label in the print buffer immediately after receiving this signal.
10	To Host	+12V - Used to power accessory items.
12	To Host	+24V - Used to power accessory items.
13	To Host	Vcc - +5V
14	Reference	Frame Ground

NOTE: The signals on pins 1, 3 4 and 6 each have an open collector output. These pins normally measure +.07V maximum when a true condition exists. If a false condition occurs, the voltage will drop to 0V. To achieve a signal level of +5V, you must add a 1K ohm, ¼ W pull-up resistor between the open collector output pin and Vcc (pin 13) as illustrated. This will provide a signal level of +5V for a true condition and 0V when a false condition exists. The maximum voltage that can be applied to these pins is +50V and the maximum current they can sink is 500 milliamps.

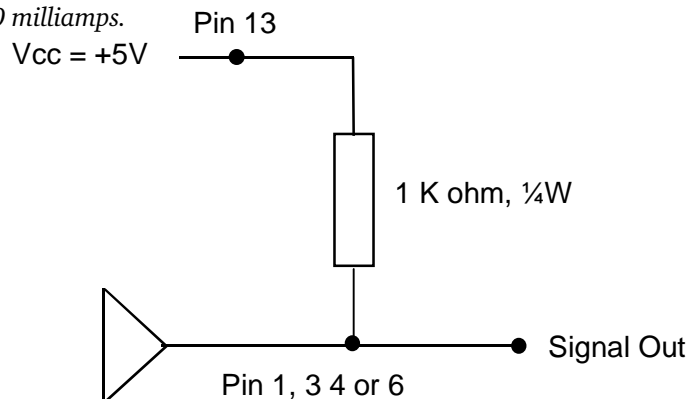

External Output Signal Types

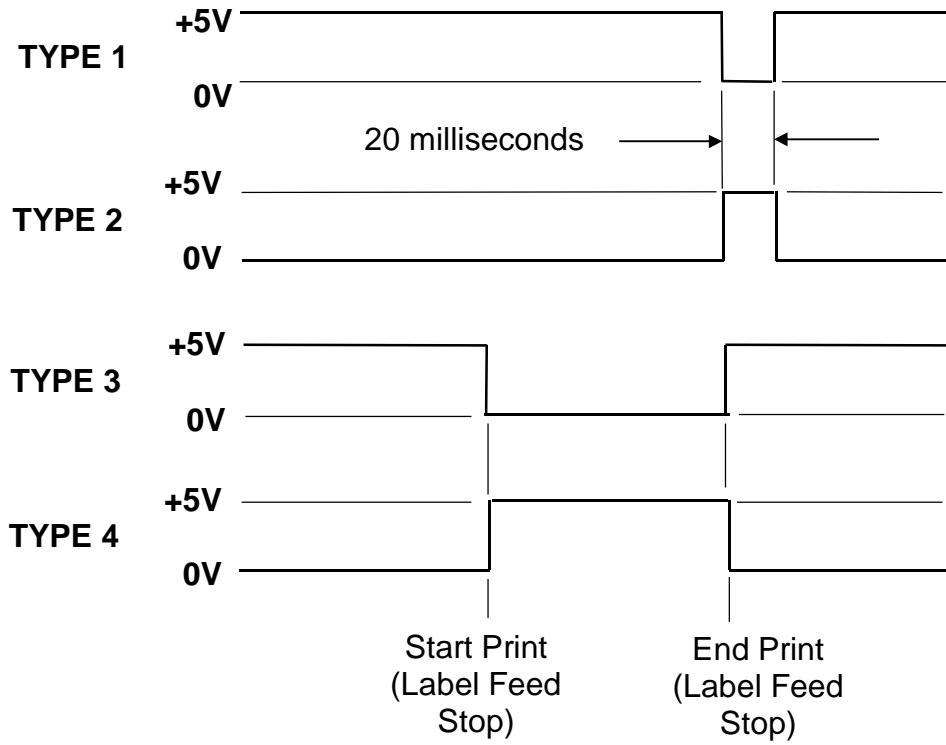



Troubleshooting

6.1 Introduction

This section has been devised to help you if you are unable to produce output on the M-5900RV. Use this section to make sure the basics have been checked before deciding you are unable to proceed any further. This section covers the following:

- Initial Checklist
- Centronics Parallel Interface
- RS232C Serial Interface
- Error Signals
- Diagnosing and Correcting Specific Problems

6.2 Initial Checklist

1. Is the printer powered up and On-Line
2. Is the in the down and latched position?
3. Verify that you've selected the appropriate label sensor in the printer configuration. See-Thru is used with label backing; Reflective is used with I-Marks on labels or tags; Non is used for continuous form labels. (See the Dip Switch Settings in Section 2.)
4. Make sure you've configured the proper RS232C interface options consistent with the host configuration.

6.3 Using the Centronics (Parallel) Interface

1. Is the IBM parallel printer cable connected securely to your parallel port (DB-25S Female) on the PC and the Centronics connector on the printer?

WARNING: Never connect or disconnect interface cables (or use a switch box) with power applied to either the printer or the host. This may cause damage to the interface circuitry and is not covered by warranty.

2. Is there more than one parallel interface port on your PC (LPT1, LPT2, etc.)? If so, make sure you are sending data out the correct port.
3. When you send the print job to the printer and it does not respond, do you get an error message on your PC that says "Device Fault" or something similar?

This may mean that the computer doesn't know the printer is there. Verify that:

- a. Both ends of the cable are securely inserted into their respective connectors.
 - b. The printer is On-Line
 - c. The cable is not defective. There are other things that can cause this error message on your computer but at this stage a defective cable may be one of the reasons.
4. When you send the print job to the printer and it does not respond and there is no error message on your computer.
 - a. Check your data stream for some of the basics. Is your job framed as follows?
<ESC>—<DATA>—<ESC>Z
 - b. Verify that you've included all required parameters in the data stream.
 - c. Verify the following:
 - You have not typed a "0" (zero) for an "O" (letter) or vice-versa.
 - You have not missed any <ESC> characters where they're needed.
 - Make sure all printer command codes are capital letters.
 - Your protocol codes are set for Standard or Non-Standard and your data stream is consistent with these.
 5. If you've checked all of the above and the printer still isn't printing, you may want to try a Receive Buffer Hex Dump to determine what (if anything) the printer is receiving from your computer. See Hex Dump Diagnostic Labels (page 2-38).

The Centronics port is now listening for incoming data. Send your print job. The printer will now print (only once), a Hexadecimal (Hex) Dump of everything it received from the host computer. Each 2-digit hexadecimal character represents a character the printer received. It may be tedious but now you can analyze and troubleshoot the data stream.

Using the Centronics (Parallel) Interface

6. While checking the Hex Dump printout, do you notice 0D 0A (Carriage Return and Line Feed) characters throughout? The command string should be continuous. No CR or LF characters are allowed between the Start Command (<ESC>A and the Stop Command (<ESC>Z. If you are using BASIC, it may be adding these characters automatically as the line wraps. Adding a "width" statement to your program can help to suppress these extra 0D 0A characters by expanding the line length up to 255 characters. See the beginning of Section 4: Programming Reference for details on writing a program in Basic.

If you're not programming in BASIC, check to see if you have an equivalent statement in the language you're using to suppress extra carriage returns and line feeds from the data being sent out to the printer. The data stream should be one complete line going to the printer.

6.4 Using the RS232C (Serial) Interface

1. Is the RS232C Serial cable connected securely to your serial port on the PC (DB-25S Male) and to the RS232C connector on the printer?

WARNING: Never connect or disconnect interface cables (or use a switch box) with power applied to either the printer or the host. This may cause damage to the interface circuitry and is not covered by warranty.

2. Is the cable defective? At the very least, you should be using a "Null Modem Cable" which crosses pins in a specific manner. This should enable your printer to print. But we recommend that you eventually use a cable built to specifications as described in Section 5: Interface Specifications.
3. Check for obvious errors in the data stream. Remember that all print jobs for serial data must be framed by an `STX` and `ETX`. Again, see Section 5 if necessary.
4. If after sending your job to the printer it only "beeps" (or displays a Framing Error message on the LCD panel) indicating a "framing error" message, you may have a configuration problem. There may be some inconsistencies with the Baud Rate, Parity, Data Bits, or Stop Bits in relation to your host computer. If you are confused as to what the printer's current RS232C settings are, you may choose the SATO defaults (all DIP switches in the OFF position) to achieve 9600 baud, no parity, 8 databits, and 1 stop bit.
5. If you still are unable to get printer output, try the Hex Dump as described in Step 5 under the Centronics Interface troubleshooting. In this case the printer monitors its RS232C interface for incoming data.
6. While checking the Hex Dump printout, do you notice 0D 0A (Carriage Return and Line Feed) characters throughout? The command string should be continuous. No CR or LF characters are allowed between the Start Command (`<ESC>A`) and the Stop Command (`<ESC>Z`). If you are using BASIC, it may be adding these characters automatically as the line wraps. Adding a "width" statement to your program can help to suppress these extra 0D 0A characters by expanding the line length up to 255 characters. See the beginning of Section 4: Programming Reference for details on writing a program in Basic.

If you're not programming in BASIC, check to see if you have an equivalent statement in the language you're using to suppress extra carriage returns and line feeds from the data being sent out to the printer. The data stream should be one complete line going to the printer.

6.5 Error Signals

LCD MESSAGE	BEEP SIGNAL	POSSIBLE CAUSE	ACTION
MACHINE ERROR	1 Long	Defective Main Circuit Board	Contact your Service Provider or SATO Service
MACHINE ERROR	1 Long	Machine Error	Cycle Power ON/OFF
EEPROM ERROR	1 Long	1) Incorrect EEPROM Installation 2) Overwritten EEPROM 3) Damaged EEPROM	Contact your Service Provider or SATO Service
HEAD ERROR	3 Short	Print Head is damaged	Contact your Service Provider or SATO Service
SENSOR ERROR	3 Short	1) Media meandering 2) Wrong sensor adjustment 3) Wrong sensor type selected	Check Media Guides Cycle Power ON/OFF
CARD RW ERROR	1 Long	1) No Card is installed 2) Store or recall invalid number 3) Card is not formatted 4) Card is set with write protection	Perform action to correct condition
CARD LOW Battery	1 Long	Memory Card Battery Low	Replace Battery Cycle Power ON/OFF
HEAD OPEN	3 Short	Head Open	Close Head Lever
CUTTER ERROR	3 Short	Cutter Jammed or Non-functional	Clear Cutter Cycle Power ON/OFF
PARITY ERROR	3 Short	1) Incorrect Parameter set 2) Wrong Cable Connection	Correct parity to match system Must use Null Modem cable
OVERRUN ERROR	3 Short	1) Incorrect Parameter set 2) Wrong Cable Connection	Verify settings Must use Null Modem cable
FRAMING ERROR	3 Short	1) Incorrect Parameter set 2) Wrong Cable Connection	Verify settings Must use Null Modem cable
BUFFER OVER	3 Short	1) Data received exceeds the receive buffer size 2) Data received from host ignores buffer-near full signal from host	Verify settings Cycle Power ON/OFF
PAPER END	3 Short	1) Out of labels or stock meandering 2) Sensors out of adjustment or damaged.	Replenish Media Select correct Media Type Open/close Head Lever
MEDIA ERROR	3 Short	Media Error	Open/close Head Lever

6.6 Diagnosing and Correcting Specific Problems

Symptoms	Possible Cause	Action
Main Power		
Display Panel is not illuminated	Power cable not connected	Verify cable is connected to printer and proper AC outlet
	Bad DC Power Supply	Contact your Service Provider or SATO Service
Label Feed		
Label not feeding	Labels loaded incorrectly	Load labels properly
	Wrong label sensor selected	Set DIP switch for correct label sensor type
	Dirt on platen roller	Clean the platen
	Platen not rotating correctly	Contact your Service Provider or SATO Service
	Stepper Motor problem	Contact your Service Provider or SATO Service
Label not stopping at the proper position	Wrong label sensor selected	Set DIP switch for correct label sensor type
	Improper label sensor level	Contact your Service Provider or SATO Service
	Improper label use	Check to see if the label and backing paper/I-Mark levels are equivalent to SATO media requirements
	Faulty main circuit board	Contact your Service Provider or SATO Service

Diagnosing and Correcting Specific Problems

Symptoms	Possible Cause	Action
Label Feed		
Label moves from side to side	Labels loaded incorrectly	Load labels properly
	Label roll is unaligned	Set the label roll with the Label Unwind Guide and Adjustable Label Edge Guide
	Print head is unbalanced	Contact your Service Provider or SATO Service
	Dirt on platen roller	Clean the platen
	Faulty platen roller	Contact your Service Provider or SATO Service
	Platen roller is unbalanced*	Contact your Service Provider or SATO Service
	Dirt on platen roller*	Contact your Service Provider or SATO Service
	Faulty platen roller*	Contact your Service Provider or SATO Service
* Applicable only for printers with dispensers		
Print		
Printer does not print	Interface cable	Check connections between the computer and printer
	Data input error	Verify that the data stream sent was correct
	Printer interface configuration	Set DIP switch to match host RS232 configuration
* Also check Label Feed troubleshooting section		
Printer creates blank label	Improper media	Verify that the media is direct thermal paper
	Data input error	Verify that the data stream sent is correct
	Print head connector	Power off the printer and verify that the printer head connector is secure
	Faulty print head	Contact your Service Provider or SATO Service
	Faulty main circuit board	Contact your Service Provider or SATO Service

Diagnosing and Correcting Specific Problems

Symptoms	Possible Cause	Action
Extraordinary Print Problems		
Print image is too dark	Improper print darkness setting	Refer to Section 3 for adjusting the print quality
Print image is too light	Improper print darkness setting	Refer to Section 3 for adjusting the print quality
	Improper label use	Use high sensitivity direct thermal media
	Improper print head setting	Refer to Section 2 or contact your Service Provider or SATO Service
	Faulty print head	Contact your Service Provider or SATO Service
	Faulty main circuit board	Contact your Service Provider or SATO Service
Uneven print darkness	Dirty print head	Refer to Section 3
	Unbalanced print head	Contact your Service Provider or SATO Service
	Worn out print roller	Contact your Service Provider or SATO Service
* Also check Label Feed troubleshooting section		
Printer creates blank label	Improper media	Verify that the media is direct thermal paper
	Data input error	Verify that the data stream sent is correct
	Print head connector	Power off the printer and verify that the printer head connector is secure
	Faulty print head	Contact your Service Provider or SATO Service
	Faulty main circuit board	Contact your Service Provider or SATO Service

Diagnosing and Correcting Specific Problems

Symptoms	Possible Cause	Action
Extraordinary Print Problems		
Improper print start position (vertically)	Improper data input	Verify the data stream and resend
	Improper sensor level	Refer to Section 2 to adjust the print sensor
	Improper pitch sensor	Refer to Section 2 to adjust the print sensor
Improper print start position (horizontal)	Improper data input	Verify the data stream and resend
	Label moves from side to side	Refer to page6-9 this section
Shortened print image	Dirty platen roller	Refer to Section 3and clean the platen
	Worn out platen	Contact your Service Provider or SATO Service
Vertical white line in print image	Dirty print head	Refer to Section 3 and clean the print head
	Faulty print head	Contact your Service Provider or SATO Service
Rewinder for Backing Paper (Dispenser Option)		
Backing paper cannot be rewound	Improper loading of backing paper	Reload it properly
	Rewind belt has been cut	Contact your Service Provider or SATO Service
	Rewind belt is off track	Contact your Service Provider or SATO Service
	Faulty rewind belt	Contact your Service Provider or SATO Service

Diagnosing and Correcting Specific Problems

Symptoms	Possible Cause	Action
Dispenser (Optional)		
Label is not dispensed	Improper loading of label/backing paper	Reload it properly.
	Improper installation of dispenser unit	Refer to Section 2 to adjust the print sensor
	Pressure spring comes off	Contact your Service Provider or SATO Service
	Unbalanced pressure roller	Contact your Service Provider or SATO Service
	Dirt on pressure roller	Clean the pressure roller
	Faulty Pressure roller	Contact your Service Provider or SATO Service
Printer feeds/dispenses labels continuously	Wrong DIP switch setting	Set the DIP switch properly for dispenser use
	Improper dispenser sensor level	Adjust the sensor level
	Faulty main circuit board	Contact your Service Provider or SATO Service
Cutter (Option)		
Cutter does not work	Improper DIPswitch setting	Set DIP switch properly for cutter use
	Improper position of cutter blade	Initialize cutter by pressing the feed key
	Loose cutter connection	Check all cutter connections
	Dirt on cutter blade	Clean the cutter blade. Use extreme care when cleaning the cutter blade
	Faulty cutter	Replace the cutter or contact your Service Provider or SATO Service

A

Command Code Quick Reference

INSTRUCTION	DESCRIPTION	PAGE
-------------	-------------	------

A	Start Code. Begins all print jobs.	Page 4-76
A(space)Z	Form Feed. Feeds a blank tag or label.	Page 4-42
AR	Normal Print Length. This command resets the printer to the Standard print length (7 inches).	Page 4-59
AX	Expanded Print Length. This command sets the printer to the Expanded print length (14 inches).	Page 4-59
A3H-aaaa Vbbbb	Base Reference Point. Establishes a new base reference point position in dots for the current label. Units of measurement are dots. - = Optional character. If included will shift reference point in negative direction.	Page 4-21

M-5900RV	
aaaa = Horizontal Print Offset	+/- 0832
bbbb = Vertical Print Offset	0001-1424

Babbcccd	Bar Codes. Prints a 1:3 ratio bar code	Page 4-13
a =	0 Codabar	
	1 Code 39	
	2 Interleaved 2 of 5 (1 2/5)	
	3 UPC-A/EAN-13	
	4 EAN-8	
	5 Industrial 2 of 5	
	6 Matrix 2 of 5	
	7 reserved	
	8 reserved	
	9 Code 128	
	A MSI	
	B reserved	
	C Code 93	
	D reserved	
	E UPC-E	
	F Bookland	
	G Code 128	
	I UCC 128	
bb =	Number of dots (01-12) for narrow bar and narrow space	
ccc =	Bar height in dots (001-600)	
d =	UCC 128 only	
	0 No human readable text	
	1 Human readable at top	
	2 Human readable at bottom	

INSTRUCTION	DESCRIPTION	
BDabbcccd	<p>Bar Codes. Prints a 2:5 ratio bar code except for UPC, EAN, Code 93, Code 128 and UCC128 symbols, which are fixed width bar codes. For values a, bb, ccc and d see instructions for Babbcccd.</p> <p>For UPC/EAN bar codes, this command puts descender bars and human readable text below the symbol.</p>	Page 4-13
BKaabbccdd eeeffnn...n	<p>PDF417. Prints PDF-417 2-D symbols</p> <p>aa = Minimum module dimension (03-09 dots). Will not print for values of 01, 02 or >/- 10.</p> <p>bb = Minimum module pitch dimension (04-240 dots). Will not print for values of 01, 02, 03 or greater than 25.</p> <p>c = Security level (1-8)</p> <p>dd = Code words per line (01-30). If 00 is specified for dd and ee, printer will automatically optimize settings.</p> <p>ee = Rows/symbol (00 or 03). If 00 is specified for dd and ee, printer will automatically optimize settings.</p> <p>fff = Number of characters to be encoded (0001-2700).</p> <p>nn...n = Data to be printed</p>	Page 4-106
BPn...n	<p>Postnet. Prints Postnet bar codes.</p> <p>n...n = 5 digit Zip (Postnet-32 format) 6 digit (Postnet-37 format) 9 digit ZIP+4 (Postnet-52 format) 11 digit ZIP+4+DPC (Postnet-62 Delivery Point format)</p>	Page 4-57
BTabbbccdde	<p>Bar Codes. Variable Ratio. Provides the ability to print a bar code with a ratio other than those specified through the standard bar code commands (B, BD, and D).</p> <p>a = Bar Code option 0 Codabar 1 Code 39 2 Interleaved 2 of 5 5 Industrial 2 of 5 6 Matrix 2 of 5</p> <p>bb = Narrow space in dots (01-99)</p> <p>cc = Wide space in dots (01-99)</p> <p>dd = Narrow bar in dots (01-99)</p> <p>ee = Wide bar in dots (01-99)</p>	Page 4-19
BVaaa,bbb, cccccc,dddd, ee...e	<p>Maxicode.. Prints Version 0 2-D Maxicode symbols.</p> <p>aaa = Service class, numeric only (001-999)</p> <p>bbb = Country code, numeric only (001-999)</p> <p>cccccc= ZIP code alphanumeric (000000-999999)</p> <p>dddd = Extended ZIP code, numeric only (0001-9999)</p> <p>ee...e = Low priority message, alphanumeric, 84 characters</p>	Page 4-104

INSTRUCTION DESCRIPTION

- BWaabbb** **Bar Codes. Expansion.** Works together with the BT command to specify an expansion factor and the bar code height for the particular symbol being printed. Page 4-18
 aa = Expansion factor by which the width of all bars and spaces is increased (01-12)
 bbb = Bar height by dot (004-600 dots)
- BXaabbbccdd eeffffghh** **Data Matrix. Data Format.** Specifies the format of the Data Matrix 2-D symbology. Page 4-99
 aa = Format ID (01-16, The values 07 and 17 will not be accepted).
 bb = Error correction level (00, 01, or 04-14, the values 02, 03 or >/-15 will not be accepted).
 cc = Horizontal cell size (03-12 dots/cell)
 dd = Vertical cell size (03-12 dots/cell)
 eee = Cells per line. Must use 000 for optimized symbol.
 fff = Cell lines. Must use 000 to optimize.
 g = Mirror image
 0 Normal Print
 1 Reverse Print
 hh = Guide cell thickness (01-15) 01 indicates normal type
- C** **Repeat Label.** Prints a duplicate of the last label printed. Page 4-65
- CSa** **Print Speed Selection.** Specifies a unique print speed in in./sec through software for a particular label. Page 4-64

	DSW2-8 Off (Default)	DSW2-8 On (Compatible)
a = Speed Setting	2 = 2 ips (50 mm/s) 3 = 3 ips (75 mm/s) 4 = 4 ips (100 mm/s) 5 = 5 ips (125 mm/s)	1 or 2 = 2 ips (50 mm/s) 3 = 3 ips (75 mm/s) 4 = 4 ips (100 mm/s) 5 = 5 ips (125 mm/s)

- Dabbcccd** **Bar Codes.** Prints 1:2 ratio bar code. For UPC and EAN bar codes. This will add descender bars. For values a, bb, ccc and d see instructions for Babbcccd. Page 4-13
- DCxx...x** **Data Matrix. Print Data.** Prints data using Data Matrix format specified in BX Data Format command. Page 4-101
 xx...x = Data to be printed. Cannot exceed 500 characters.
- Eaaa** **Line Feed.** Provides the ability to print multiple lines of the same character size without specifying a new print position for each line. Page 4-52
 aaa = Number of dots (1-999) between the bottom of the characters on one line to the top of the characters on the next line.

INSTRUCTION	DESCRIPTION	
Faaaabcccc ddee	<p>Sequential Numbering. Allow the printing of sequencing fields (text, bar codes) where all incrementing is done within the printer.</p> <p>aaa = Number of times to repeat the same data (0001-9999) b = Plus or minus symbol (+ for increments; - for decrements) cccc = Value of step for sequence (001 - 9999) dd = No. of digits for sequential numbering (01-99, default = 8) ee = No. of digits free from sequential numbering (01-99, default = 0)</p>	Page 4-74
FWaaHbbbb	<p>Horizontal Line. Prints a horizontal line. Units of measurement are dots.</p>	Page 4-50
FWaabbVccc Hdddd	<p>Box. Prints a box. For values aa, bbb, cc and dddd, see instructions for horizontal and vertical lines. Units of measurement are dots.</p>	Page 4-50
FWccVddd	<p>Vertical Line. Prints a vertical line. Units of measurement are dots.</p>	Page 4-50
M-5900RV		
FXaaabcccc dddeee	<p>Data Matrix. Sequential Numbering. Prints sequential numbered Data Matrix 2-D symbols.</p> <p>aaa = Number of duplicate labels (001-999) b = Increment or decrement + Increment - Decrement ccc = Increment/decrement steps (001-999) ddd = Sequential numbering start position (001-999). Referenced to left side. eee = Incremented data length (001-999) Measured from start position.</p>	Page 4-102

INSTRUCTION DESCRIPTION

Gabbccc(data) **Custom Graphics.** Allows the creation and printing of graphic images using a dot-addressable matrix. Page 4-45

- a = Specifies format of data stream to follow
 - B Binary
 - H Hexadecimal
- bbb = Number of horizontal 8 x 8 blocks (001-152)
- ccc = Number of vertical 8 x 8 blocks (001-178 or 001-356 for 14" label)
- data = Data to describe the graphic image

GPaaaa **PCX File.** Downloads PCX file to the internal graphics image memory. Page 4-47

- aaaa= No. of bytes to be downloaded (max DOS file size = 32K).

Haaaa **Horizontal Position.** Specifies a field's horizontal location across the width of the label from the current base reference point. The units of measurement are dots. Page 4-61

M-5900RV	
aaaa = New Horizontal Position	0001 - 0896

IDaa **Store Job ID.** Stores the Job ID number. Page 4-48

- aa = Job ID number assigned (01-99)

J **Journal Print.** Provides the ability to print text line by line. Fixed spacing between lines and characters. Page 4-49

Kab90cc **Recall Custom Designed Characters.** Recalls for printing a custom character stored by the Tabcc(data) command. Page 4-23

- a = 1 16 x 16 matrix
- 2 24 x 24 matrix
- b = Indicates the format that data stream was stored in.
 - B Binary
 - H Hexadecimal
- bb = Memory location where the character was stored. Valid locations are 21 to 52 or "!" to "R" in hex values

Laabb **Character Expansion.** Expands characters in both directions. Page 4-25

- aa = Multiple to expand horizontally (01-12)
- bb = Multiple to expand vertically (01-12)

LD,a,b,c,d,e,f,g,h,i **Download Protocol Command Codes.** Downloads a user defined set of Alternate Protocol Command Codes. See Appendix E for details on the proper usage of this command. Page 4-97

M **Font type.** Specifies the 13W x 20H dot matrix font (including descenders). Page 4-36

N **Rotate.** Moving Base Reference Point. Sets the original base reference point and returns printing to normal orientation. Page 4-72

INSTRUCTION	DESCRIPTION
-------------	-------------

OA **Font type.** Specifies the OCR-A font with dot matrix. Page 4-36

M-5900RV	
OA Font Matrix	15W x 22H

OB **Font type.** Specifies the OCR-B font with dot matrix. Page 4-36

M-5900RV	
OB Font Matrix	20W x 24H

Paa **Character Pitch.** Designates the number of dots between characters. Page 4-28

aa = Number of dots between characters (01-99)

PR **Fixed Font Spacing.** Returns the printer to fixed character spacing mode. Page 4-27

PS **Proportional Font Spacing.** Places the printer in the proportional character spacing mode. Will not work with U Font. Page 4-30

Qaaaaa **Print Quantity.** Specifies the total number of labels to print. Page 4-63
 aaaaa = Total number of labels to print for the job.
 (000001-999999)

R **Rotate, Moving Base Reference Point.** Rotates the printing of all subsequent images by 90 degrees counterclockwise each time it is used. Also moves the base reference point. Page 4-72

RMaaaa,bbbb **Mirror Image.** Prints mirror image of data. Page 4-54
 aaaa = Horizontal distance in dots of the image area to be mirrored.
 bbbb = Vertical distance in dots of the image area to be mirrored.

S **Font type.** Specifies the 8W x 15H dot matrix font (including descenders). Page 4-36

Tabcc(data) **Store Custom Designed Characters.** To create and store custom characters or images in the printer's volatile memory. See Kab90cc to recall the character for printing. Page 4-23
 a = 1 16 x 16 matrix
 2 24 x 24 matrix
 b = Specifies data stream format to follow
 B Binary
 H Hexadecimal
 cc = Memory location to store the character.
 Valid locations are 21 to 52 or "!" to "R" in hex values.
 (data) = Data to describe the character.

U **Font type.** Specifies a 5W x 9H dot matrix font (including descenders). Page 4-36

INSTRUCTION	DESCRIPTION
-------------	-------------

Vbbbb **Vertical Position.** Specifies a field's vertical location Page 4-61
down the length of the label from the current base reference
point. The units of measurement are dots.

M-5900RV	
bbbb = New Vertical Position	0001-1424

WBa **Font type.** Specifies the 18W x 30H dot matrix font (including Page 4-40
descenders).

- a = 0 Disables auto-smoothing of font
 1 Enables auto-smoothing if expansion is greater than 3.

WDHaaaaVbbbb **Copy Image Area.** To copy an image to another location of Page 4-33
XccccYdddd the label.

- aaaa = Horizontal position of the top left corner of image area
bbbb = Vertical position of the top left corner of image area
cccc = Horizontal length of image area
dddd = Vertical length of image area

WLa **Font type.** Specifies the 28W x 52H dot matrix font (including Page 4-40
descenders).

- a = 0 Disables auto-smoothing of font
 1 Enables auto-smoothing if expansion is greater than 3

XBa **Font type.** Specifies the 48W x 48H dot matrix font (including Page 4-40
descenders).

- a = 0 Disables auto-smoothing of font
 1 Enables auto-smoothing if expansion is greater than 3

XLa **Font type.** Specifies the 48W x 48H dot matrix font Page 4-40
(including descenders).

- a = 0 Disables auto-smoothing of font
 1 Enables auto-smoothing if expansion is greater than 3

XM **Font type.** Specifies the 24W x 24H dot matrix font (including Page 4-36
descenders).

XS **Font type.** Specifies the 17W x 17H dot matrix font (including Page 4-36
descenders).

XU **Font type.** Specifies the 5W x 9H dot matrix font (including Page 4-36
descenders).

XWa **Font type.** Specifies the 48W x 48H dot matrix font (including Page 4-40
descenders).

- a = 0 Disables auto-smoothing of font
 1 Enables auto-smoothing if expansion is greater than 3

Z **Stop Code.** Ends all print jobs. Page 4-76

INSTRUCTION DESCRIPTION

%a **Rotate. Fixed Base Reference Point.** Rotates printing in 90° increments without changing the base reference point. Page 4-70
 a = 0 Sets print to normal direction
 1 Sets print to 90° CCW
 2 Sets print to 180° rotated (upside down)
 3 Sets print to 270° CCW (90° CW)

\$a,b,c,d **Vector font.** Specifies printing of the unique SATO vector font. Page 4-38
 a = A Helvetica Bold (proportional spacing)
 B Helvetica Bold (fixed spacing)
 b = Font width (50-999 dots*)
 c = Font height (50-999 dots*)
 d = Font variation (0-9) as follows:
 0 Standard
 1 Standard open (outlined)
 2 Gray (mesh) Pattern 1
 3 Gray (mesh) Pattern 2
 4 Gray (mesh) Pattern 3
 5 Standard, shadow 1
 6 Standard, shadow 2
 7 Standard mirror image
 8 Italic
 9 Italic open (outlined)

\$(data) **Data for Vector font.** Page 4-38

#Ea **Print Darkness.** Specifies a new print darkness setting. The lightest setting is "1". Page 4-58

M-5900RV	
a = Print Darkness	1, 2, 3, 4 or 5

(aaaa,bbbb) **Reverse Image.** Reverse image from black to white and vice versa. Units of measure are dots. Page 4-68

M-5900RV	
aaaa = Horizontal Length	0001 - 0896
bbbb = Vertical Length	0001-1424

& **Store form Overlay.** Stores a specified label image in the printer's volatile form overlay memory. Page 4-44

/ **Recall form Overlay.** Recalls the label image from the printer's overlay memory for printing. Page 4-43

0 (zero) **Replace Data (Partial Edit).** Provides the ability to replace a specified area of the previous label with new data. Page 4-66

INSTRUCTION	DESCRIPTION	
*a	<p>Clear Print Job(s) and Memory. Clears individual memory and buffers.</p> <p>a = When not included in command, clears print jobs in Multi-Buffer mode</p> <p>a = If included in command, specifies memory section to be cleared.</p> <p>T Custom character memory, printer</p> <p>& Form overlay memory, printer</p> <p>X Clears all memory of memory and buffers</p>	Page 4-31
@,nn...n	<p>Off-Line/Pause. Signals the printer to go off-line after the completion of a print job.</p> <p>nn...n = Optional 32 character message to be displayed on the LCD.</p>	Page 4-56
~aaaa	<p>Cutter Command. Controls the cutting of labels when using the optional SATO cutter unit. (A<NULL> can be used in place of the "~" .)</p> <p>aaaa = Number of labels to print between each cut (0000-9999)</p>	Page 4-35

Calendar Option Commands

WA(elements)	<p>Calendar Print. Prints the date and/or time field (up to 16 characters) from the printer's internal clock. Use slash to separate date elements and colon to separate time elements.</p> <p>elements = YY 2 digit Year (00-91)</p> <p>YYYY 4 digit Year (1981-2080)</p> <p>MM Month (01-12)</p> <p>DD Day (01-31)</p> <p>HH 12 Hour Clock (00-11)</p> <p>hh 24 Hour Clock (00-23)</p> <p>mm Minutes (00-59)</p> <p>ss Seconds (00-59)</p> <p>TT AM or PM</p> <p>JJJ Julian Date (000-366)</p> <p>WW Week (00-53)</p> <p>ww Week (01-54)</p>	Page 4-79
WPabbb	<p>Calendar Increment. To add a value to the printer's current date and/or time. Does not change the printer's internal setting.</p> <p>a = Y Years</p> <p>M Months</p> <p>D Days</p> <p>h hours</p> <p>bbb = Numeric data. Years (1-9), Months (01-99), Weeks (00-99), Days (001-999), Hours (001-999).</p>	Page 4-77
WTAabbccdde	<p>Calendar Set. To set the time and date of the printer's internal clock.</p> <p>aa = Year (00-99)</p> <p>bb = Month (01-12)</p> <p>cc = Day (01-31)</p> <p>dd = Hour (00-23)</p> <p>ee = Minute (00-59)</p>	Page 4-81

INSTRUCTION	DESCRIPTION
-------------	-------------

Memory Card Option Commands

BJ(aa..abb..b	Start TrueType Font Storage. Prepares the Memory Card to accept TrueType font data aa...a = 40 byte font description bb...b = 10 byte data field	Page 4-86
BJDccccddddd ee...e	Download TrueType Font Data. Downloads the TrueType font data to the memory area specified. cccc = Memory Offset (hexadecimal) dddd = Data size in bytes (max = 2000) ee...e = Font data to be downloaded	Page 4-86
BJ)	End TrueType Font Storage. Ends the TrueType font storage process.	Page 4-86
BJFaaaaaaaa	Initialize Memory Card. Initializes the Memory Card and formats it for use. Should be preceded by the Slot Select command for the card to be initialized. aaaaaaaa = 8 character alphanumeric password.	Page 4-94
BJRabbccddd eefffgg..g	TrueType Font Recall. Recalls a previously stored TrueType font for use. a = Font ID (1-9) bb = Horizontal Expansion (01-12) cc = Vertical Expansion (01 - 12) dd = Character pitch (01-99) ee = Always 00 fff = Number of characters gg..g = Data to be printed using font	Page 4-85
BJJS	Memory Card Status. Reports the status of the currently active Memory Card to the host by printing a status label.	Page 4-96
BJTaa,bb,cc, dd,ee,fff,gg..g	TrueType Font Recall. Recalls a previously stored TrueType font for use. aa = Font ID (01-99) bb = Horizontal Expansion (01-12) cc = Vertical Expansion (01 - 12) dd = Character pitch (01-99) ee = Always 00 fff = Number of characters gg..g = Data to be printed using font	Page 4-85
CCa	Slot Select. Selects the Memory Card Slot for all following Memory Card commands. a = 1 Slot 1 b = 2 Slot 2	Page 4-95

INSTRUCTION	DESCRIPTION	
EXa	<p>Expand Memory Area. Expands the memory area used by the printer to image the label.</p> <p>a = 0 Return to using internal printer RAM</p> <p>1 Use Memory Card in Slot 1</p> <p>2 Use Memory Card in Slot 2</p>	Page 4-83
Glabbcccd ee...e	<p>Store Custom Graphics. Stores a graphic image in the memory card to be called later for printing on a label.</p> <p>a = 0 Specifies format of data stream to follow</p> <p>B Binary</p> <p>H Hexadecimal</p> <p>bbb = Number of horizontal 8 x 8 blocks (001-248)</p> <p>ccc = Number of vertical 8 x 8 blocks (001-267 for 7" label)</p> <p>dd = Graphics storage number (01-99)</p> <p>ee...e = Data to describe the graphic image</p>	Page 4-90
GRcc	<p>Recall Custom Graphics. Recalls for printing the graphic image stored by the GI command.</p> <p>cc = Storage number (01-99)</p>	Page 4-89
Pla,bbbb, cc...c	<p>Store PCX Graphics File. Stores a PCX graphic file</p> <p>aa = Storage number (01-99)</p> <p>bbbb= Number of bytes in the file to be stored</p>	Page 4-93
PYaa	<p>Recall PCX Graphics File. Recalls a PCX graphic file</p> <p>aa = The storage number assigned to the file (01-99)</p>	Page 4-92
YR,aa /D,bb,cc...c	<p>Recall Format/Field. To recall a field from a format previously stored in the memory card.</p> <p>aa = Number of format to be recalled (01-99)</p> <p>bb = Number of field to be recalled (01-99)</p> <p>cc...c = Data to placed in field</p>	Page 4-87
YS,aa /Nbb,cc	<p>Store Format/Field. To store a field from a format previously stored in the memory card.</p> <p>aa = Format number</p> <p>bb = Field number (01-99)</p> <p>cc = Number of characters in the field</p>	Page 4-88
*abb	<p>Clear Card Memory. Clears individual memory and</p> <p>a = Memory section to be cleared</p> <p>G SATO graphic files (01-99)</p> <p>P PCX graphic file (01-99)</p> <p>F Stored formats (01-99)</p> <p>O TrueType fonts, memory card (01-09)</p> <p>bb = Storage number</p>	Page 4-82



Bar Code Specifications

BAR CODE SYMBOLOGIES

This section contains detailed information on the printing of bar codes on the M-5900RV printers. Information on printing the following bar code sybologies is provided.

- Codabar
- Code 39
- Interleaved 2 of 5
- UPC-A/EAN-13
- EAN-8
- Industrial 2 of 5
- Matrix 2 of 5
- Code 128
- MSI
- Code 93
- UPC-E
- UPC Supplements (Bookland)
- UCC-128
- Postnet
- Data Matrix
- Maxicode
- PDF417

Codabar

Command Structure

1:3 ratio <ESC>**B0bbcccd (data) d**
 2:5 ratio <ESC>**BD0bbcccd (data) d**
 1:2 ratio <ESC>**D0bbcccd (data) d**

bb = Width of narrow element in dots (01-12)
 ccc = Bar height in dots (001-600)
 d = Required Start and Stop character (asterisk)
 (data) = Bar code data (alphanumeric)

Character Set

0-9, -, \$, :, /, +
 A, B, C, D (Start/Stop characters)

Density Table

Narrow/Wide Ratio	Value of "bb"	"X" Dimension (mils)	Density (char/inch)
1:3	01	5.0	16.9
1:3	02	10.0	8.5
2:5	01	10.0	9.2
1:2	02	5.0	10.2

Example

<ESC>H0400<ESC>V0025<ESC>**B002100A124345B**

<ESC>H0440<ESC>V0135<ESC>XS12345

Notes

You must add the appropriate (A, B, C or D) Start and Stop characters to the data string. The printer does not automatically add them when printing.



Code 39

Command Structure

1:3 ratio <ESC>B**bbccc*** (data) *
 2:5 ratio <ESC>BD**1bbccc***(data) *
 1:2 ratio <ESC>D**1bbccc*** (data) *

bb = Width of narrow element in dots (01-12)
 ccc = Bar height in dots (001-600)
 * = Required Start and Stop character (A, B, C, or D)
 (data) = Bar code data (alphanumeric)

Character Set

0-9, A-Z, Space, \$,%,+,-,.,/
 * (Start/Stop characters)

Density Table

Narrow/Wide Ratio	Value of "bb"	"X" Dimension (mils)	Density (char/inch)
1:3	01	5.0	12.7
1:3	02	10.0	6.4
2:5	01	10.0	7.0
1:2	01	5.0	15.6
1:2	02	10.0	7.8

Example

<ESC>H0100<ESC>V0025<ESC>B**103100***CODE 39*
 <ESC>H0230<ESC>V0130<ESC>X**S***CODE 39*

Notes

You must add the "*"Start and Stop characters to the data string. The printer does not automatically add them when printing.



Interleaved Two of Five (I 2/5)

Command Structure

1:3 ratio <ESC>B2bbccc (data)
 2:5 ratio <ESC>BD2bbccc*(data)
 1:2 ratio <ESC>D2bbccc* (data)

bb = Width of narrow element in dots (01-12)
 ccc = Bar height in dots (001-600)
 (data) = Bar code data (numeric); must be an even number of digits or else the printer will add a leading zero; start and stop code are provided by the printer.

Character Set

0-9 (numeric only)

Density Table

Narrow/Wide Ratio	Value of "bb"	"X" Dimension (mils)	Density (char/inch)
1:3	01	5.0	22.6
1:3	02	10.0	11.3
2:5	01	10.0	12.7
1:2	01	5.0	14.5
1:2	02	10.0	9.7

Example

```
<ESC>H0100<ESC>V0100<ESC>B20310045676567
<ESC>H0140<ESC>V0210<ESC>XM4567 66567
```

Notes

To add horizontal guard bars to the top and bottom of bar code, use the Line and Box command (see page 4-50).



UPC-A/EAN-13

Command Structure

<ESC>**B3bbccc (data)**
 <ESC>**D3bbccc(data)**
 <ESC>**BD3bbccc(data)**

bb = Width of narrow element in dots (01-12)
 ccc = Bar height in dots (001-600)
 (data) = Bar code data (numeric); must be exactly 13 digits.
 For UPC-A, the first digit must be zero and the last 11 digits are the actual UPC-A data followed by a check digit.

To select UPC-A, 11 digits of data is sent. The printer adds a "0" and automatically generates the check digit. If 12 digits of data is sent, the printer assumes an EAN-13 symbol and automatically generates the check digit. The last digit of the bar code data is a modulo 10 check digit. If 13 digits of data is sent to the printer, the check digit is not created and must be supplied by the programmer. It must be the last character in the 13 digit string and can be determined by using the calculations outlined below.

Character Set

0-9 (numeric only)

Density Table

Value of "bb"	Narrow Bar Width (mils)	Magnification Factor
02	10.0	75%
03	15.0	112%
04	20.0	150%

Example

<ESC>H0100<ESC>V0375<ESC>**BD30215001234567890**

Notes

D3 provides guide bars that extend longer than the rest of the bar code. **BD3** provides guide bars and the human readable text below the symbol.



UPC-A/EAN-13 (Cont)

Calculating the Mod 10 Check Digit

If you wish to encode the UPC-A data "01234567890", follow these steps to find the correct check digit.

ODD	0		2		4		6		8		0	
EVEN		1		3		5		7		9		CD

1. First add all the numbers in the ODD positions.
i.e., $0 + 2 + 4 + 6 + 8 + 0 = 20$
2. Multiply the result of Step 1 by 3.
i.e., $20 \times 3 = 60$
3. Add all the numbers in the EVEN positions.
i.e., $1 + 3 + 5 + 7 + 9 = 25$
4. Add the result of Step 2 to that of Step 3.
i.e., $60 + 25 = 85$
5. Subtract the result of Step 4 from the next highest increment of 10.
i.e., $90 - 85 = 5$
6. The correct Modulo 10 check digit for the 11 digit string "01234567890" is 5.

EAN-8

Command Structure

<ESC>B4bbccc (data)

<ESC>D4bbccc (data)

bb = Width of narrow element in dots (01-12)

ccc = Bar height in dots (001-600)

(data) = Bar code data (numeric); must be exactly 8 digits.

Character Set

0-9 (numeric only)

Density Table

Value of "bb"	Narrow Bar Width (mils)	Magnification Factor
02	10.0	75%
03	15.0	112%
04	20.0	150%

Example

<ESC>H0400<ESC>V0375<ESC>BD4031001234567

Notes

1. D4 provides guide bars that extend longer than the rest of the bar code and the human readable text below the symbol.
2. The check digit is automatically calculated for EAN-8.



Industrial Two of Five

Command Structure

1:3 ratio <ESC>**B5bbccc (data)**
2:5 ratio <ESC>**BD5bbccc (data)**
1:2 ratio <ESC>**D5bbccc (data)**

bb = Width of narrow element in dots (01-12)
ccc = Bar height in dots (001-600)
(data) = Bar code data (numeric); must be an even number of digits or else the printer will add a leading zero.

Character Set

0-9 (numeric only)

Example

<ESC>H0100<ESC>V0600<ESC>**BD50310012345**
<ESC>H0300<ESC>V0710<ESC>XS12345

Notes

To add horizontal guard bars to the top and bottom of bar code, use the Line and Box command (see page 4-50).



Matrix Two of Five

Command Structure

1:3 ratio <ESC>**B6bbccc (data)**
 2:5 ratio <ESC>**BD6bbccc (data)**
 1:2 ratio <ESC>**D6bbccc (data)**

bb = Width of narrow element in dots (01-12)
 ccc = Bar height in dots (001-600)
 (data) = Bar code data (numeric); must be an even number of digits or else the printer will add a leading zero.

Character Set

0-9 (numeric only)

Example

<ESC>H0100<ESC>V0775<ESC>**BD60310012345**
 <ESC>H0230<ESC>V0885<ESC>XS12345

Notes

To add horizontal guard bars to the top and bottom of bar code, use the Line and Box command (see page 4-50).



CODE 128

Command Structure

<ESC>**B**Gbbccdd (data)

- bb = Width of narrow element in dots (01-12)
- ccc = Bar height in dots (001-600)
- dd = Start code to specify initial subset of bar code data
 - >G Subset A Start code
 - >H Subset B Start code
 - >I Subset C Start code
- (data) = Includes bar code data and subset Shift codes; Shift codes are used to change the subset type within the bar code data.

Shift codes:

- >E Subset A Start code
- >D Subset B Start code
- >C Subset C Start code

Character Set

See Code 128 Character Table on Page B-23

Density Table

Value of "bb"	"X" Dimension (mils)	Density (char/inch)	
		Subsets A, B	Subset C
01	5.0	18.2	36.5
01	10.0	9.1	18.3
03	15.0	13.8	12.2

Example

The following will start in Subset A for the characters "AB", shift to Subset B for "789", then shift to Subset C for "123456".

```
<ESC>H0200<ESC>V0550<ESC>BG03100<b>GAB</b><b>B789</b><b>C123456</b>
<ESC>H0310<ESC>V655<ESC>XSAB789123456
```



MSI

Command Structure

1:3 ratio <ESC>**BA**bbccc (data) d
 2:5 ratio <ESC>**BD**Abbccc (data) d
 1:2 ratio <ESC>**DA**bbccc (data) d

bb = Width of narrow element in dots (01-12)
 ccc = Bar height in dots (001-600)
 (data) = Bar code data (numeric); maximum of 15 digits
 d = Required check digit

Character Set

0-9 (numeric only)

Example

<ESC>H0100<ESC>V0950<ESC>**BA03100123455**
 <ESC>H0170<ESC>V1060<ESC>XS12345



CODE 93

Command Structure

1:3 ratio: <ESC>**BC**bbccdd (data)

bb = Width of narrow element in dots (01-12)

ccc = Bar height in dots (001-600)

dd = Length of data (number of digits, 00-99)

(data) = Bar code data (alphanumeric); length must match value of parameter "dd"; check digit is supplied by printer

Character Set

0-9, A-Z, -,., Space, \$,/+,%

Density Table

Narrow/Wide Ratio	Value of "bb"	"X" Dimension (mils)	Density (char/inch)
1:3	01	5.0	22.5
1:3	02	10.0	11.3
1:3	03	15.0	7.5

Example

<ESC>H0100<ESC>V1125<ESC>**BC03100081234ABCD**

<ESC>H0155<ESC>V1240<ESC>XS1234ABCD



UPC-E

Command Structure

<ESC>BEbbccc (data)

<ESC>DEbbccc(data)

bb = Width of narrow element in dots (01-12)

ccc = Bar height in dots (001-600)

(data) = Bar code data (numeric); must be exactly 6 digits.

Character Set

0-9 (numeric only)

Density Table

Value of "bb"	Narrow Bar Width (mils)	Magnification Factor
02	10.0	75%
03	15.0	112%
04	20.0	150%

Example

<ESC>H0400<ESC>V0550<ESC>DE03100123456

<ESC>H0375<ESC>V0600<ESC>OB0

<ESC>H0408<ESC>V0655<ESC>OB123456

Notes

Command **DE** provides guide bars that extend longer than the rest of the bar code.



BOOKLAND (UPC/EAN Supplements)

Command Structure

<ESC>BFbbccc (data)

- bb = Width of narrow element in dots (01-12)
- ccc = Bar height in dots (001-600)
- (data) = Bar code data (numeric); must be exactly 2 or 5 digits

Character Set

0-9 (numeric only)

Density Table

Value of "bb"	Narrow Bar Width (mils)	Magnification Factor
02	10.0	75%
03	15.0	112%
04	20.0	150%

Example

```
<ESC>H0325<ESC>V0725<ESC>D30315009827721123
<ESC>L0101<ESC>H0295<ESC>V0800<ESC>OB0
<ESC>H0340<ESC>V0878<ESC>OB98277
<ESC>H0480<ESC>V0878<ESC>OB21123
<ESC>H640<ESC>V0760<ESC>BF0313021826
<ESC>H655<ESC>V0730<ESC>OB21826
```



UCC-128

Command Structure

<ESC>Blbbcccd (data)

- bb = Width of narrow element in dots (01-12)
ccc = Bar height in dots (001-600)
d = Placement of human readable text
0 None
1 Text at top of bar code
2 Text at bottom of bar code
(data) = 17 digits made up of the following:
1st digit = Container type
digits 2-8, Shipper identification
digits 9-17, Container Sequential
Note: The Container Sequential number is not automatically sequenced by the printer.

Character Set

See Code 128 Character Table on Page B-23

Density Table

See Code 128, Page B-10

Notes

1. The Start, Function, Stop and Extension codes will be created by the printer and added automatically.
2. The internal Modulo 10 check character will be automatically created and added by the printer. The overall Code 128 symbol check character will be automatically created by the printer and added.
3. The automatically created human readable text will be created according to the following rules:
 - The spacing between the bar code and the text is fixed at 10 dots (.050 inches).
 - If the width of the human readable text is wider than the bar code, it will start at the same position as the bar code and extend past the right of the bar code.
 - If the width of the human readable text is less than the bar code, it will be centered on the bar code.
 - The automatically generated human readable font is OCR-B.
 - If any part of the human readable text extends outside the printable area, none of it will be printed. Care should be exercised when placing the bar code to allow for any automatically created human readable text.

UCC-128 (Cont)

Example

Without incrementing

<ESC>A

<ESC>H0100<ESC>V0100<ESC>**B104150101234567000000001**

<ESC>Q2<ESC>Z



With incrementing

<ESC>A

<ESC>H0100<ESC>V0100<ESC>F001+001

<ESC>**B104150101234567000000001**

<ESC>Q2<ESC>Z



Postnet

Command Structure

<ESC>BP (data)

data = 5 digits ZIP
= 6 digits for Postnet 37
= 9 digits for ZIP + 4
= 11 digits for Delivery Point Bar Code

Character Set

1-9 (numeric only)

Notes

1. Frame bits and check digits added automatically by printer.
2. Bar code width and height are fixed and cannot be changed.
3. If the number of digits sent to the printer as data does not match one of the formats specified above (i.e. 5, 6, 9 or 11), the command is ignored and nothing will be printed.
4. If a "-" is included in the data stream (i.e. 84093-1565), it is ignored.

Example

<ESC>H0100<ESC>V0120<ESC>BP94089
<ESC>H0100<ESC>V0160<ESC>BP123456
<ESC>H0100<ESC>V0200<ESC>BP123456789
<ESC>H0100<ESC>V0240<ESC>BP12345678901



Data Matrix

Command Structure

Data Format

<ESC>BXaabbccddeeffghh

- aa = Format ID, 01-06 or 11-16. The values 07 and 17 will not be accepted by the printer.
- bb = Error correction level. 00, 01, 04 -14 or 20. All other values will be processed as a 00.
- cc = Horizontal cell size, 03 -12 dots/cell.
- dd = Vertical cell size 03 -12 dots/cell.
- eee = Number of cells in one line. Must use 000 to optimize.
- fff = Number of cell lines. Must use 000 to optimize.
- g = Mirror Image
 - 0 = Normal Print
 - 1 = Reverse Print
- hh = Guide Cell Thickness. 01-15.01 indicates normal type.

Sequential Numbering <ESC>FXaabbccdddeee

- aaa = Number of duplicate labels to be printed (001-999)
- b = Increment of Decrement
 - + = Increment
 - = Decrement
- ccc = Increment/Decrement Steps (001 - 999)
- ddd = Sequential numbering start position (001 - 999) referenced to left side.
- eee = Incremented data length measured from start position (001 - 999)

Print Data

<ESC>DCxxx...x

xx...x = Data

Data Matrix (Cont)

Character Set

ECC Level (bb)	Format ID (aa)					
	01	02	03	04	05	06
00 (ECC000)	500	452	394	413	310	271
05 (ECC050)	457	333	291	305	228	200
08 (ECC080)	402	293	256	268	201	176
10 (ECC100)	300	218	190	200	150	131
14 (ECC140)	144	105	91	96	72	83
20 (ECC200)	Numeric				3116	
	Alphanumeric				2336	
	ISO 8 bit (01 _H - FF _H)				1556	

ID NUMBER	CHARACTER SET	ENCODING SCHEME
16 Bit CRC		
01	Numeric, Space	Base 11
02	Upper Case Alpha, Space	Base 27
03	Upper Case Alpha, Space, Comma, Period, Slash, Minus	Base 41
04	Upper Case Alphanumeric, Space	Base 37
05	ASCII 7-bit, Full Keyboard (20 _H - 7F _H)	ASCII
06	ISO 8-bit, International (20 _H - FF _H)	8-Bit

Notes

See AIM USA Technical Specification Data Matrix for information on the structure of this symbology.

Example

```
<ESC>H0100<ESC>V0100
<ESC>BX05051010000000001
<ESC>DCDATA MATRIX DATA MATRIX
```



Maxicode

Command Structure

<ESC>BVa,b,c,ddddddddd,eee,fff,gggg....<ESC>

- a = Position of Maxicode symbol within the set, when used in a structured append format 1-8
- b = Total number of Maxicode symbols in the set, when used in a structured format 1~8.
- c = 2 For Mode 2 Structured Carrier Message for Domestic U.S. UPS shipments
 3 For Mode 3 Structured Carrier Message for International UPS shipments
 4 Standard symbol
 5 Not currently supported
 6 Reader programming
- ddd..ddd 9 digit numeric Postal Code
- eee = 3 digit numeric County Code
- fff = 3 digit numeric Service Code
- gg..g = Data, terminated by <ESC>

Character Set

MODE	POSTAL CODE	COUNTRY CODE	SERVICE CLASS	MESSAGE LENGTH
2	9 digits max numeric only	3 digits max numeric only	3 digits max numeric only	84 characters alphanumeric
3	6 digits fixed alphanumeric	3 digits max numeric only	3 digits max numeric only	84 characters alphanumeric
4 6	"000000" fixed data	"000" fixed data	"000" fixed data	91 characters alphanumeric

Notes

See AIM USA Technical Specification Data Matrix for information on the structure of this symbology.

Example

```
<ESC>A<ESC>V0100<ESC>H0100
<ESC>BV1,1,2,123456789,840,001,)]<RS>01<GS>961Z01547089
<GS>UPSN<GS>056872<GS>349<GS>99999999<GS>001/005
<GS>029<GS>N<GS><GS>LENEXA<GS>KS<RS><EOT>
<ESC>Q001<ESC>Z
```



PDF417

Command Structure

<ESC>BFaabbcddeefffnnn...n

- aa = Minimum module dimension (03-09 dots). Will not print if values of 01, 02 or greater than 10 are specified.
- bb = Minimum module pitch dimension (04-24 dots). Will not print if values of 01, 02, 03 or greater than 25 are specified.
- c = Security (error detection) Level (1-8).
- dd = Code words per line (01-30). If 00 is specified for both dd and ee, the printer automatically optimizes the number of rows per symbol.
- ee = Rows per symbol (00 or 03-40). If 00 is specified for both dd and ee, the printer automatically optimizes the number of rows per symbol.
- fff = Number of characters to be encoded (0001-2700).
- nn...n = Data to be printed.

Character Set

ASCII 128 character set plus PC437 Extended Character set.

Notes

See AIM USA Uniform Symbology Specification PDF417 for information on the structure of this symbology.

Example

<ESC>V0100<ESC>H0100<ESC>BK0607400000021PDF417 PDF417 PDF417



CODE 128 Character Table

The Code 128 Table lists 105 data values for the three subsets: A, B, and C. Each subset column displays either a single column of data or a double column of data.

- If the subset column displays a single column of data, that is the data to be entered to produce the result.
- If the subset column displays a double column of data, the first column contains the desired output and the second column contains the actual characters to be entered.

For example, look at value 99 in the table:

If you are currently using Subset A or Subset B, you can change to Subset C by encoding ">C".

VALUE	SUBSET A	SUBSET B	SUBSET C
99	Subset C >C	Subset C >C	99
100	Subset B >D	FNC4 >D	Subset B >D
101	FNC4 >E	Subset A >E	Subset A >E
102	FNC1 >F	FNC1 >F	FNC1 >F

Note: When Subset C is chosen, you must specify an even number of data positions because of the interleaved encodation method.

CODE 128 Character Table

VALUE	SUBSET A	SUBSET B	SUBSET C	VALUE	SUBSET A	SUBSET B	SUBSET C
0	SP	SP	00	36	D	D	36
1	!	!	01	37	E	E	37
2	"	"	02	38	F	F	38
3	#	#	03	39	G	G	39
4	\$	\$	04	40	H	H	40
5	%	%	05	41	I	I	41
6	&	&	06	42	J	J	42
7	'	'	07	43	K	K	43
8	((08	44	L	L	44
9))	09	45	M	M	45
10	*	*	10	46	N	N	46
11	+	+	11	47	O	O	47
12	,	,	12	48	P	P	48
13	-	-	13	49	Q	Q	49
14	.	.	14	50	R	R	50
15	/	/	15	51	S	S	51
16	0	0	16	52	T	T	52
17	1	1	17	53	U	U	53
18	2	2	18	54	V	V	54
19	3	3	19	55	W	W	55
20	4	4	20	56	X	X	56
21	5	5	21	57	Y	Y	57
22	6	6	22	58	Z	Z	58
23	7	7	23	59	[[59
24	8	8	24	60	\	\	60
25	9	9	25	61]]	61
26	:	:	26	62	^	^	62
27	;	;	27	63	_	_	63
28	<	<	28	64	NUL >(space)	' >(space)	64
29	=	=	29	65	SOH >!	a or >!	65
30	>	>	30	66	STX >"	b or >"	66
31	?	?	31	67	ETX >#	c or >#	67
32	@	@	32	68	EOT >\$	d or >\$	68
33	A	A	33	69	ENQ >%	e or >%	69
34	B	B	34	70	ACK >&	f or >&	70
35	C	C	35	71	BEL >'	g or >'	71

CODE 128 Character Table (Cont)

VALUE	SUBSET A	SUBSET B	SUBSET C	VALUE	SUBSET A	SUBSET B	SUBSET C
72	BS >(h or >(72	89	EM >9	y or >9	89
73	HT >)	i or >)	73	90	SUB >:	z or >:	90
74	LF >*	j or >*	74	91	ESC >;	{ or >;	91
75	VT >+	k or >+	75	92	FS ><	l or ><	92
76	FF >,	l or >,	76	93	GS >=	} or >=	93
77	CR >-	m or >-	77	94	RS >>	~ or >>	94
78	SO >.	n or >.	78	95	US >?	DEL >?	95
79	SI >/	o or >/	79	96	FNC3 >@	FNC3 >@	96
80	DLE >0	p or >0	80	97	FNC2 >A	FNC2 >A	97
81	DC1 >1	q or >1	81	98	SHIFT >B	SHIFT >B	98
82	DC2 >2	r or >2	82	99	Subset C >C	Subset C >C	99
83	DC3 >3	s or >3	83	100	Subset B >D	FNC4 >D	Subset B >D
84	DC4 >4	t or >4	84	101	FNC4 >E	Subset A >E	Subset A >E
85	NAK >5	u or >5	85	102	FNC1 >F	FNC1 >F	FNC1 >F
86	SYN >6	v or >6	86	103	SUBSET A START CODE >G		
87	ETB >7	w or >7	87	104	SUBSET B START CODE >H		
88	CAN >8	x or >8	88	105	SUBSET C START CODE >I		

Custom Characters and Graphics

Custom-Designed Character Example

The following example is presented to help you understand the use of the Custom-Designed Characters command. It demonstrates the design and printing of an "arrow" in a 16 x 16 matrix.

1. Determine which matrix to use.
 - 16 dots x 16 dots
 - 24 dots x 24 dots
2. Lay out a grid and draw the image on the grid.
 - Each square represents one dot
 - Blacken squares for each printed dot

	1	2	3	4	5	6	7	8	1	2	3	4	5	6	7	8
1								■								
2							■	■								
3						■	■	■								
4				■	■	■	■	■								
5				■	■	■	■	■	■							
6			■	■	■	■	■	■	■	■						
7		■	■	■	■	■	■	■	■	■	■					
8	■	■	■	■	■	■	■	■	■	■	■	■				
1																
2																
3																
4																
5																
6																
7																
8																

- Transfer the image into two bit map representations and then into hexadecimal or binary format.

ROW	BIT MAP				HEX	
1	0000	0001	0000	0000	01	00
2	0000	0011	1000	0000	03	80
3	0000	0111	1100	0000	07	C0
4	0000	1111	1110	0000	0F	E0
5	0001	1111	1111	0000	1F	F0
6	0011	1111	1111	1000	3F	F8
7	0111	1111	1111	1100	7F	FC
8	1111	1111	1111	1110	FF	FE
9	0000	0111	1100	0000	07	C0
10	0000	0111	1100	0000	07	C0
11	0000	0111	1100	0000	07	C0
12	0000	0111	1100	0000	07	C0
13	0000	0111	1100	0000	07	C0
14	0000	0111	1100	0000	07	C0
15	0000	0111	1100	0000	07	C0
16	0000	0111	1100	0000	07	C0

- To store the custom designed character in memory using a hexadecimal data stream, the command would be:

```
<ESC>A
<ESC>T1H3F0100038007C00FE01FF03FF87FFCFFFE07C007C007C007C007007007007C0
<ESC>Z
```

- To recall the custom character from memory, send the following code to the printer. Note that you can print other data as well. Also note how the character size was expanded using the <ESC>L command.

```
<ESC>A
<ESC>L0505<ESC>H0150<ESC>V100<ESC>K1H903F
<ESC>L0505<ESC>H0600<ESC>V100<ESC>K1H903F
<ESC>L0303<ESC>H0125<ESC>V0250<ESC>MTHIS SIDE UP!
<ESC>Q1
<ESC>Z
```

- To store the custom designed character in memory using a binary data stream, the command would be:

```
<ESC>A
<ESC>T1B3F 01H 00H 03H 80H 07H C0H 0FH E0H 1FH F0H 3FH F8H 7FH FCH FFH FEH
07H C0H 07H C0H 07H C0H 07H C0H 07H C0H 07H C0H 07H C0H 07H C0H 07H C0H
<ESC>Z
```

Note: Spaces are shown between hexadecimal values in the above example for clarity only and are not to be included in the data string.

7. To recall the custom character from memory, send the following code to the printer:

```
<ESC>A  
<ESC>L0505<ESC>H0150<ESC>V100<ESC>K1B903F  
<ESC>L0505<ESC>H0600<ESC>V100<ESC>K1B903F  
<ESC>L0303<ESC>H0125<ESC>V0250<ESC>MTHIS SIDE UP!  
<ESC>Q1  
<ESC>Z
```

The printer output for both the hexadecimal and binary format examples is:

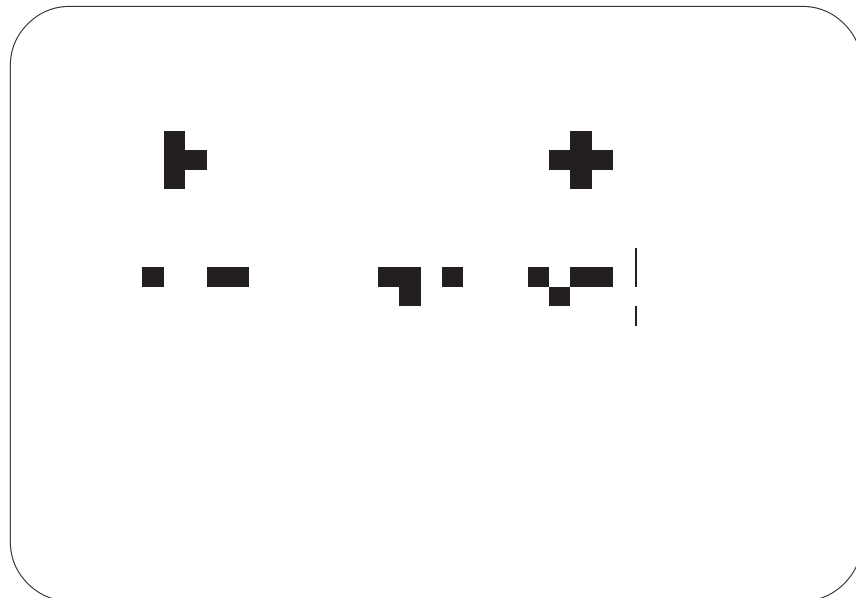

CUSTOM GRAPHICS EXAMPLE

The following example is presented to help you understand the use of the Custom Graphics command. It demonstrates the design and printing of an "diskette" in a 48 x 48 matrix.

1. Determine the matrix size for the graphic. It must be in 8 dot by 8 dot blocks. The example here has six blocks horizontally and six blocks vertically (48 x 48).
2. Lay out a grid and draw the image on the grid.
 - Each square represents one dot
 - Blacken squares for each printed dot

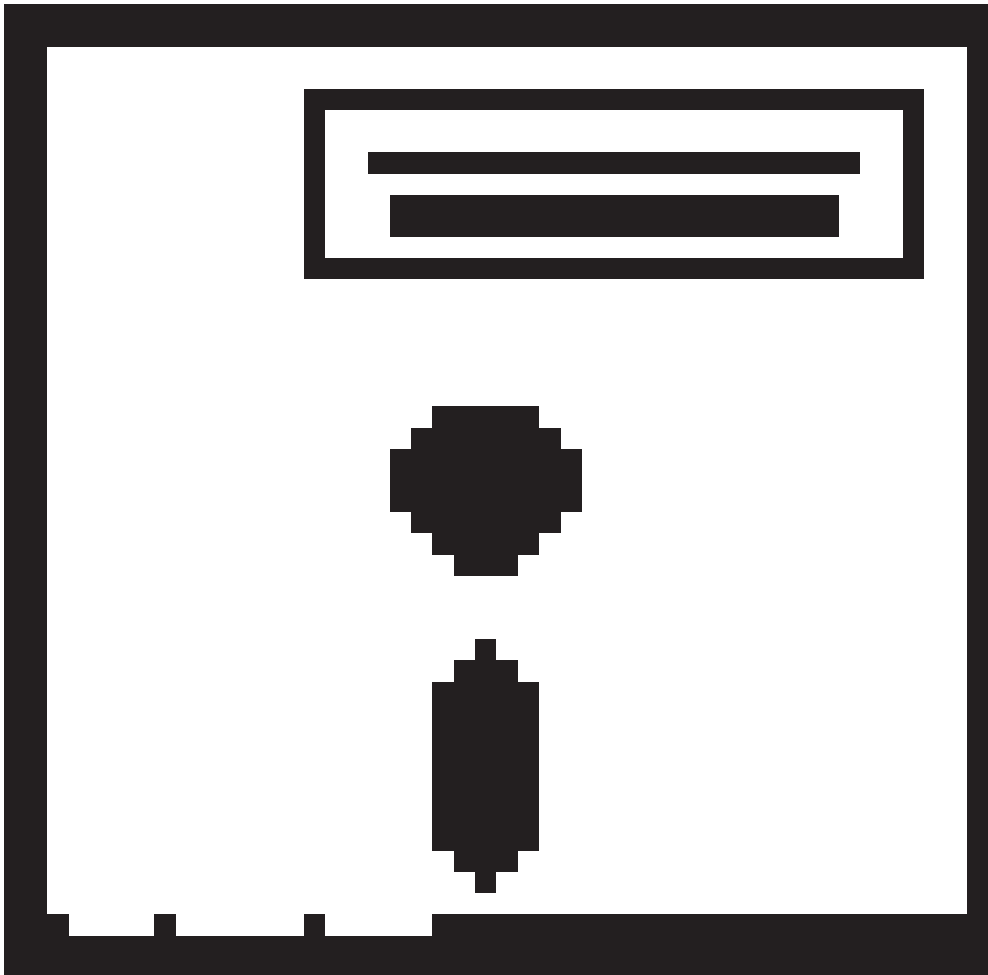

3. Transfer the image into a bit map representation and then into hexadecimal format:

BIT MAP						HEXADECIMAL FORMAT					
1	2	3	4	5	6	1	2	3	4	5	6
11111111	11111111	11111111	11111111	11111111	11111111	FF	FF	FF	FF	FF	FF
11111111	11111111	11111111	11111111	11111111	11111111	FF	FF	FF	FF	FF	FF
11000000	00000000	00000000	00000000	00000000	00000011	C0	00	00	00	00	03
11000000	00000000	00000000	00000000	00000000	00000011	C0	00	00	00	00	03
11000000	00000000	11111111	11111111	11111111	11110011	C0	00	FF	FF	FF	03
11000000	00000000	10000000	00000000	00000000	00010011	C0	00	80	00	00	13
11000000	00000000	10000000	00000000	00000000	00010011	C0	00	80	00	00	13
11000000	00000000	10011111	11111111	11111111	00010011	C0	00	9F	FF	FF	13
11000000	00000000	10000000	00000000	00000000	00010011	C0	00	80	00	00	13
11000000	00000000	10000000	00000000	00000000	00010011	C0	00	80	00	00	03
11000000	00000000	10011111	11111111	11111111	00010011	C0	00	9F	FF	FF	13
11000000	00000000	10000000	00000000	00000000	00010011	C0	00	80	00	00	13
11000000	00000000	10000000	00000000	00000000	00010011	C0	00	80	00	00	13
11000000	00000000	10000000	00000000	00000000	00010011	C0	00	80	00	00	13
11000000	00000000	11111111	11111111	11111111	11110011	C0	00	FF	FF	FF	F3
11000000	00000000	00000000	00000000	00000000	00000011	C0	00	00	00	00	03
11000000	00000000	00000000	00000000	00000000	00000011	C0	00	00	00	00	03
11000000	00000000	00000000	00000000	00000000	00000011	C0	00	00	00	00	13
11000000	00000000	00000000	00000000	00000000	00000011	C0	00	00	00	00	13
11000000	00000000	00000011	11000000	00000000	00000011	C0	00	03	C0	00	03
11000000	00000000	00000111	11100000	00000000	00000011	C0	00	07	E0	00	03
11000000	00000000	00001111	11110000	00000000	00000011	C0	00	0F	F0	00	03
11000000	00000000	00001111	11110000	00000000	00000011	C0	00	0F	F0	00	03
11000000	00000000	00001111	11110000	00000000	00000011	C0	00	0F	F0	00	03
11000000	00000000	00001111	11110000	00000000	00000011	C0	00	0F	F0	00	03
11000000	00000000	00001111	11110000	00000000	00000011	C0	00	0F	F0	00	03
11000000	00000000	00001111	11110000	00000000	00000011	C0	00	07	E0	00	03
11000000	00000000	00000011	11000000	00000000	00000011	C0	00	03	C0	00	03
11000000	00000000	00000000	00000000	00000000	00000011	C0	00	00	00	00	03
11000000	00000000	00000000	00000000	00000000	00000011	C0	00	00	00	00	03
11000000	00000000	00000000	00000000	00000000	00000011	C0	00	00	00	00	03
11000000	00000000	00000000	00000000	00000000	00000011	C0	00	00	00	00	03
11000000	00000000	00000000	00000000	00000000	00000011	C0	00	00	00	00	03
11000000	00000000	00000000	00000000	00000000	00000011	C0	00	00	00	00	03
11000000	00000000	00000000	00000000	00000000	00000011	C0	00	00	00	00	03
11000000	00000000	00000001	10000000	00000000	00000011	C0	00	01	80	00	03
11000000	00000000	00000011	11000000	00000000	00000011	C0	00	03	C0	00	03
11000000	00000000	00000011	11000000	00000000	00000011	C0	00	03	C0	00	03
11000000	00000000	00000011	11000000	00000000	00000011	C0	00	03	C0	00	03
11000000	00000000	00000011	11000000	00000000	00000011	C0	00	03	C0	00	03
11000000	00000000	00000011	11000000	00000000	00000011	C0	00	03	C0	00	03
11000000	00000000	00000011	11000000	00000000	00000011	C0	00	03	C0	00	03
11000000	00000000	00000011	11000000	00000000	00000011	C0	00	03	C0	00	03
11000000	00000000	00000011	11000000	00000000	00000011	C0	00	03	C0	00	03
11000000	00000000	00000011	11000000	00000000	00000011	C0	00	03	C0	00	03
11000000	00000000	00000001	10000000	00000000	00000011	C0	00	01	80	00	03
11000000	00000000	00000000	00000000	00000000	00000011	C0	00	03	C0	00	03
11000000	00000000	00000000	00000000	00000000	00000011	C0	00	03	C0	00	03
11111111	11111111	11111111	11111111	11111111	11111111	FF	FF	FF	FF	FF	FF
11111111	11111111	11111111	11111111	11111111	11111111	FF	FF	FF	FF	FF	FF

- Using the hexadecimal data, send the following code to print the graphic image as designed.

```
<ESC>A<ESC>H0100<ESC>V0100<ESC>GH006006
FFFFFF FFFFFFF FFFFFFF FFFFFFF C00000 000003
C00000 000003 C000FF FFFFF3 C00080 000013
C00080 000013 C0009F FFFF13 C00080 000013
C00080 000013 C0009F FFFF13 C00080 000013
C00080 000013 C000FF FFFFF3 C00000 000003
C00000 000003 C00000 000003 C00000 000003
C00000 000003 C00000 000003 C00003 C00003
C00007 E00003 C0000F F00003 C0000F F00003
C0000F F00003 C0000F F00003 C00007 E00003
C00003 C00003 C00000 000003 C00000 000003
C00000 000003 C00000 000003 C00001 800003
C00003 C00003 C00003 C00003 C00003 C00003
C00003 C00003 C00003 C00003 C00003 C00003
C00003 C00003 C00003 C00003 C00003 C00003
C00003 C00003 C00001 800003 C00000 000003
C00000 000003 FFFFFFF FFFFFFF FFFFFFF FFFFFFF
<ESC>Q1<ESC>Z
```

- To send the data in binary format, the software must convert the data into binary format before transmitting it to the printer. Using the BASIC programming language for example, this is done by notation "CHR\$ (&HC0)" which sends the hexadecimal value of "C0" as binary data (11000000). The BASIC program listing for sending this graphic to the printer (using the RS232 port) in binary format is:

```
CLS
OPEN "COM2:9600,N,8,1,CS,DS" FOR OUTPUT AS #1
E$ = CHR$(27)
PRINT#1, CHR$(2);E$;"A";E$;"V0100";E$;"H0100";E$;"GB006006";
PRINT#1, CHR$(&HFF);CHR$(&HFF);CHR$(&HFF);CHR$(&HFF);CHR$(&HFF);
PRINT#1, CHR$(&HFF);CHR$(&HFF);CHR$(&HFF);CHR$(&HFF);CHR$(&HFF);
PRINT#1, CHR$(&HFF);CHR$(&HFF);CHR$(&HC0);CHR$(&H00);CHR$(&H00);
PRINT#1, CHR$(&H00);CHR$(&H00);CHR$(&H03);CHR$(&HC0);CHR$(&H00);
PRINT#1, CHR$(&H00);CHR$(&H00);CHR$(&H00);CHR$(&H03);CHR$(&HC0);
PRINT#1, CHR$(&H00);CHR$(&HFF);CHR$(&HFF);CHR$(&HFF);CHR$(&HF3);
PRINT#1, CHR$(&HC0);CHR$(&H00);CHR$(&H80);CHR$(&H00);CHR$(&H00);
PRINT#1, CHR$(&H13);CHR$(&HC0);CHR$(&H00);CHR$(&H80);CHR$(&H00);
PRINT#1, CHR$(&H00);CHR$(&H13);CHR$(&HC0);CHR$(&H00);CHR$(&H9F);
PRINT#1, CHR$(&HFF);CHR$(&HFF);CHR$(&H13);CHR$(&HC0);CHR$(&H00);
PRINT#1, CHR$(&H80);CHR$(&H00);CHR$(&H00);CHR$(&H13);CHR$(&HC0);
PRINT#1, CHR$(&H00);CHR$(&H80);CHR$(&H00);CHR$(&H00);CHR$(&H13);
PRINT#1, CHR$(&HC0);CHR$(&H00);CHR$(&H9F);CHR$(&HFF);CHR$(&HFF);
PRINT#1, CHR$(&H13);CHR$(&HC0);CHR$(&H00);CHR$(&H80);CHR$(&H00);
PRINT#1, CHR$(&H00);CHR$(&H13);CHR$(&HC0);CHR$(&H00);CHR$(&H80);
PRINT#1, CHR$(&H00);CHR$(&H00);CHR$(&H13);CHR$(&HC0);CHR$(&H00);
PRINT#1, CHR$(&HFF);CHR$(&HFF);CHR$(&HFF);CHR$(&HF3);CHR$(&HC0);
PRINT#1, CHR$(&H00);CHR$(&H00);CHR$(&H00);CHR$(&H00);CHR$(&H03);
PRINT#1, CHR$(&HC0);CHR$(&H00);CHR$(&H00);CHR$(&H00);CHR$(&H00);
```



```

PRINT#1, CHR$(&H03);CHR$(&HC0);CHR$(&H00);CHR$(&H00);CHR$(&H00);
PRINT#1, CHR$(&H00);CHR$(&H03);CHR$(&HC0);CHR$(&H00);CHR$(&H00);
PRINT#1, CHR$(&H00);CHR$(&H00);CHR$(&H03);CHR$(&HC0);CHR$(&H00);
PRINT#1, CHR$(&H00);CHR$(&H00);CHR$(&H00);CHR$(&H03);CHR$(&HC0);
PRINT#1, CHR$(&H00);CHR$(&H00);CHR$(&H00);CHR$(&H00);CHR$(&H03);
PRINT#1, CHR$(&HC0);CHR$(&H00);CHR$(&H03);CHR$(&HC0);CHR$(&H00);
PRINT#1, CHR$(&H03);CHR$(&HC0);CHR$(&H00);CHR$(&H07);CHR$(&H00);
PRINT#1, CHR$(&H00);CHR$(&H03);CHR$(&HC0);CHR$(&H00);CHR$(&H0F);
PRINT#1, CHR$(&HF0);CHR$(&H00);CHR$(&H03);CHR$(&HC0);CHR$(&H00);
PRINT#1, CHR$(&H0F);CHR$(&HF0);CHR$(&H00);CHR$(&H03);CHR$(&HC0);
PRINT#1, CHR$(&H00);CHR$(&H0F);CHR$(&HF0);CHR$(&H00);CHR$(&H03);
PRINT#1, CHR$(&HC0);CHR$(&H00);CHR$(&H0F);CHR$(&HF0);CHR$(&H00);
PRINT#1, CHR$(&H03);CHR$(&HC0);CHR$(&H00);CHR$(&H07);CHR$(&HE0);
PRINT#1, CHR$(&H00);CHR$(&H03);CHR$(&HC0);CHR$(&H00);CHR$(&H03);
PRINT#1, CHR$(&HC0);CHR$(&H00);CHR$(&H03);CHR$(&HC0);CHR$(&H00);
PRINT#1, CHR$(&H00);CHR$(&H00);CHR$(&H00);CHR$(&H03);CHR$(&HC0);
PRINT#1, CHR$(&H00);CHR$(&H00);CHR$(&H00);CHR$(&H00);CHR$(&H03);
PRINT#1, CHR$(&HC0);CHR$(&H00);CHR$(&H00);CHR$(&H00);CHR$(&H00);
PRINT#1, CHR$(&H03);CHR$(&HC0);CHR$(&H00);CHR$(&H00);CHR$(&H00);
PRINT#1, CHR$(&H00);CHR$(&H03);CHR$(&HC0);CHR$(&H00);CHR$(&H01);
PRINT#1, CHR$(&H80);CHR$(&H00);CHR$(&H03);CHR$(&HC0);CHR$(&H00);
PRINT#1, CHR$(&H03);CHR$(&HC0);CHR$(&H00);CHR$(&H03);CHR$(&HC0);
PRINT#1, CHR$(&H00);CHR$(&H03);CHR$(&HC0);CHR$(&H00);CHR$(&HC3);
PRINT#1, CHR$(&HC0);CHR$(&H00);CHR$(&H03);CHR$(&HC0);CHR$(&H00);
PRINT#1, CHR$(&H03);CHR$(&HC0);CHR$(&H00);CHR$(&H03);CHR$(&HC0);
PRINT#1, CHR$(&H00);CHR$(&H03);CHR$(&HC0);CHR$(&H00);CHR$(&H03);
PRINT#1, CHR$(&H00);CHR$(&H03);CHR$(&HC0);CHR$(&H00);CHR$(&H03);
PRINT#1, CHR$(&HC0);CHR$(&H00);CHR$(&H03);CHR$(&HC0);CHR$(&H00);
PRINT#1, CHR$(&H03);CHR$(&HC0);CHR$(&H00);CHR$(&H03);CHR$(&HC0);
PRINT#1, CHR$(&H00);CHR$(&H03);CHR$(&HC0);CHR$(&H00);CHR$(&H03);
PRINT#1, CHR$(&HC0);CHR$(&H00);CHR$(&H03);CHR$(&HC0);CHR$(&H00);
PRINT#1, CHR$(&H01);CHR$(&H80);CHR$(&H00);CHR$(&H03);CHR$(&HC0);
PRINT#1, CHR$(&H00);CHR$(&H00);CHR$(&H00);CHR$(&H00);CHR$(&H03);
PRINT#1, CHR$(&HC0);CHR$(&H00);CHR$(&H00);CHR$(&H00);CHR$(&H00);
PRINT#1, CHR$(&H03);CHR$(&HFF);CHR$(&HFF);CHR$(&HFF);CHR$(&HFF);
PRINT#1, CHR$(&HFF);CHR$(&HFF);CHR$(&HFF);CHR$(&HFF);CHR$(&HFF);
PRINT#1, CHR$(&HFF);CHR$(&HFF);CHR$(&HFF);
PRINT#1, E$;"Q1";E$;"Z";CHR$3
CLOSE#1
    
```

The printer output for both the hexadecimal and binary format examples is:



PCX GRAPHICS EXAMPLE

A graphics file in a PCX format may also be transmitted to the printer. The file must not be larger than 32K bytes (DOS file size reported in a DIR listing). For example, the WIZ.PCX image shown below has a file size of 15076 bytes.



The uncompressed size (PCX is a compressed file) of the file must not be greater than 64K bytes. Generally this is not a problem unless the graphic image is surrounded by a large amount of white space which the PCX algorithm can compress very efficiently. If this is the case, the file should be recaptured to eliminate the surrounding white space as much as possible.

The following basic program will send and print this file:

```
OPEN "WIZ.PCX" FOR INPUT AS #2
DA$=INPUT$(15706,#2)
C$=CHR$(27)
WIDTH"LPT1:",255
LPRINT C$;"A";
LPRINT C$;"V150";C$;"H100";C$;"GP15706,";DA$
LPRINT C$;"Q1";C$;"Z";
CLOSE #2
```



Optional Accessories

Introduction

This section contains instructions for using the following M-5900RV optional features:

- Label Rewinder
- Label Cutter
- Label Dispenser
- PCMCIA Memory Cards
- Calendar

Label Rewinder

The rewinder is an external unit that allows for labels and tags to be rewound in rolls up to 8.5 inches in diameter. It derives its power directly from the printer's EXT connector using a built-in cable. The rewinder provides the ability to rewind tags/labels from the printer and subsequently be unwound for later use with applicators.

Installation

1. Position the Rewinder at the front of the printer and align it with the label slot. The Rewind Wheel/Spindle should be positioned away from the printer.
2. Connect the built-in cable from the Rewinder to the EXT connector at the rear of the printer.
3. On the Rewinder, remove the metal clamp from the Rewind Spindle.
4. Feed the lead end of the label stock under the first spindle and onto the Rewind Spindle. Feed the stock around the spindle once, then replace the metal clamp over the label stock. Wind another revolution to ensure the labels are secure on the spindle.
5. Select the REWIND option on the rewinder, then set the power switch to ON. The printer must be powered ON for the rewinder to function.

Removing and Unwinding the Roll

As labels are printed, tension from the rewinder should keep the label stock taut as it wraps itself on the spindle.

Removing and Unwinding the Roll (Cont)

To remove the roll from the spindle, first set the power switch to **OFF**. Remove the metal clamp, then remove the rewound roll of labels.

To unwind for using with an applicator, first set the power switch OFF. Attach the lead edge of the labels from the rewind spindle to the applicator entry point. Select the WIND option of the rewinder, and when ready to getin, set the power switch to **ON**.

Label Cutter

The label cutter consists of an internal mechanism that will cut labels or tags as they exit from the printer. The cutter can be used to print labels of various lengths using continuous form label/tag stock or to easily separate labels when there is no perforation at the label gap.

Operator Setup

The following steps should be taken to set up the Label Cutter.

1. Install the label cutter, following the instructions provided with the unit.
2. Power the printer ON.
3. The printer must be configured to use the Label Cutter option. Switches DSW3-1 and DSW3-2 on the front panel are used to configure the printer. To enable the cutter, DSW3-1 should be in the ON position and DSW3-2 should be in the OFF position.

NOTE: Although the cutting blade is fairly well protected, be careful as you feed labels into the cutter area. You may want to have the printer powered OFF at this point.

5. Close the Print Head Assembly and place the printer on-line.
6. The Label Cutter is ready for use.
7. Adjust the cut position using the backfeed adjustment procedures outlined in Section 2, Installation and Configuration.

General Operation

The data stream to be sent to the printer may need to be altered to add the Cutter Command. If this command is not used, the cutter will default to cut after every label assuming it has been enabled in the printer configuration. For more details, see Section 4, Command Codes. As the labels are printed, they will be cut based on the data supplied using the cutter command.

Label Dispenser

The M-5900RV Label Dispenser Option is an external mechanism that provides the ability to print labels in the "demand" mode. It is attached to the front of the printer. When the label dispenser is installed and configured for operation the printer dispenses one label at a time, peeling the backing from the label which allows for immediate application to the product by the operator.

Operator Setup

The following steps should be taken to set up the Label Dispense option.

1. Install the Label Dispense Option, following the instructions provided with the unit.
2. Power the printer ON.
3. The printer must be configured to use the Label Dispense option. Switches DSW3-1 and DSW3-2 on the front panel are used to configure the printer. To enable the dispenser, DSW3-1 and DSW3-2 should be in the ON position.
4. Remove enough labels from the backing paper to provide 12 inches of backing free from labels.
5. Open the Print Head assembly and feed the backing paper through the print area in the normal manner.
6. At the label exit area, feed the backing paper down and behind the Knurled Roller, then back down and around the Backing Roller.
7. Feed the backing paper out the slot in the bottom rear of the printer and attach to the Backing Rewind Spindle.
8. Close the Print Head and place the printer on-line.
9. The Label Dispense option is ready to use.

General Operation

Send your data stream in the normal manner to the printer. Labels should print one at a time, even if your print quantity command requests more than one label. As the labels are printed and presented for the operator to remove, the backing paper will be rewound on the spindle. The next label will only print after removing the current label from the label exit path.

NOTE: The label dispenser will function only if it has been enabled using the front panel switches DSW3-1 and DSW3-2 in the ON positions.

The Label Taken Sensor is adjusted at the factory for the optimal setting for most label material. However, the use of labels with a substantially different opacity may require that the threshold be adjusted.

PCMCIA Memory Cards

The M-5900RV printer comes equipped with an interface connection for memory cards and is an integral part of the main PC board. Optional PCMCIA memory cards are available which will allow the printer memory to be expanded up to 4MB. The memory cards are inserted through slots labeled 1 and 2 and are located on the back panel of the printer.

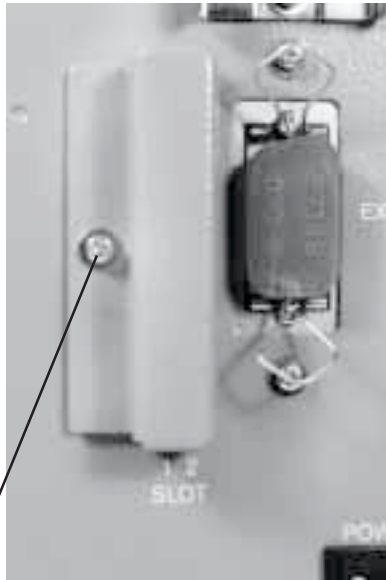

**REMOVE SCREW TO
DETACH MEMORY
SLOT COVER**

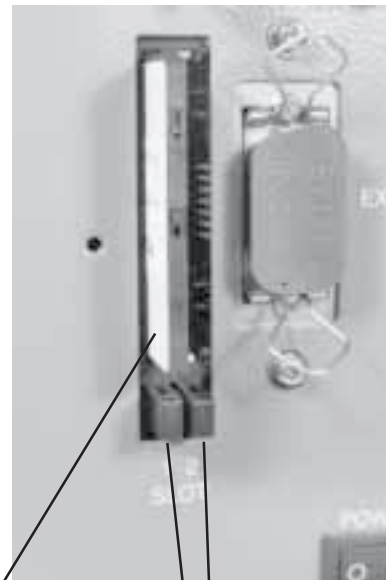

**INSERT MEMORY CARD
IN SLOT 1 OR 2**

**CARD EJECT
BUTTONS**

**MEMORY SLOT COVER MAY BE
REATTACHED OVER MEMORY CARD(S)**

MEMORY CARDS

Type	SRAM, Type 1
Applicable Specifications	PCMCIA Version 2.1 (JEIDA Version 4.1)
Size	128KB, 256KB, 512KB, 1MB or 2MB
Connector Pins	68
Battery Life	Approx. 2 years (manufacturer dependent)
Write Protect	Yes
Low Battery Detect	Yes

PCMCIA Memory Cards

To install the Memory Card(s)

1. On the back panel of the printer, remove screw to detach memory slot cover.
2. Insert card in slot 1 or 2.
3. To replace worn battery, follow illustrations below.

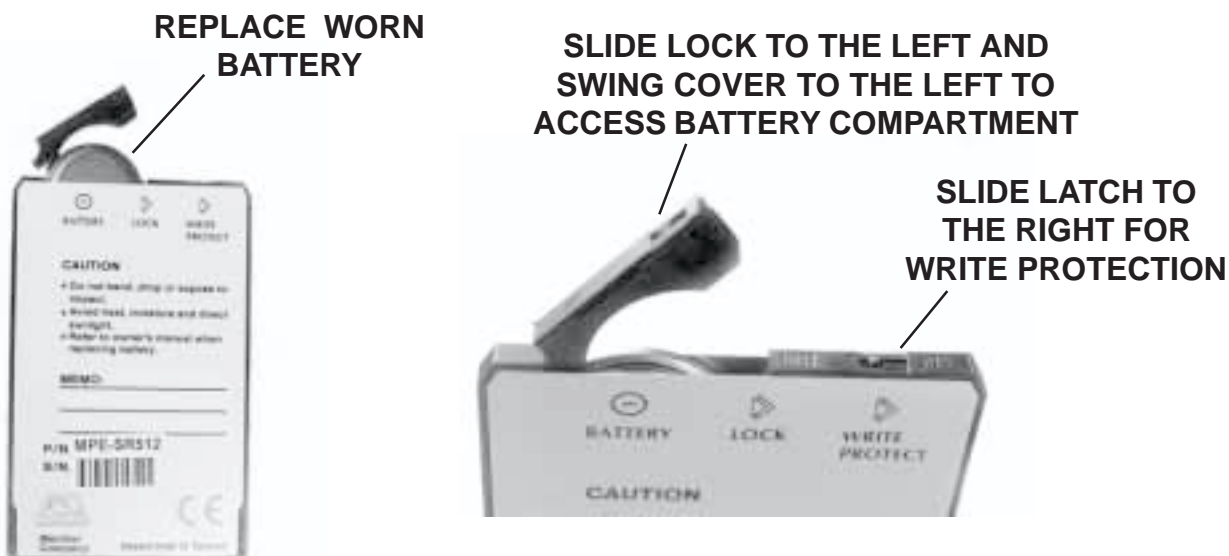

NOTE: ALL DATA STORED ON THE CARD WILL BE LOST WHEN THE BATTERY IS REPLACED

Plug-In Interface Cards

Several Plug-In Interface Cards are available for this printer. See Section 5 for types.

Follow the instructions supplied with the card(s) for installation.

Calendar

The Calendar Option allows the date and time to be maintained in the local printer rather than using the system clock. It consists of a special clock chip that replaces the EEPROM on the main PCB assembly. A qualified technician should perform the upgrade as it requires modifications to the main PCB assembly. Please call SATO Technical Support if you need to add this option to an existing printer in the field.

For this option contact Sato America



Reset

If the custom Protocol Command codes are incorrect or if the printer does not respond to commands using the custom set, the Alternate Protocol Control Codes can be restored by the following procedure.

1. Turn the printer off.
2. Place DIP switch **DS2-7** in the **ON** position.
3. Turn the power **ON** while simultaneously pressing the **FEED** and **LINE** switches.
4. When the message "ALT PROTOCOL DEFAULT COMPLETED" appears on the display panel, turn the printer off.



ALT PROTOCOL
DEFAULT COMPLETE

5. When it is powered up again, the Alternate Protocol Command Code set will be active and all previous custom settings will be lost.

Download Procedure

The procedure for downloading a custom Protocol Command Code set is:

1. Reset the printer to the default settings using the Reset procedure above.
2. Place DIP switch DS2-7 in the **ON** position.
3. Turn the power on while simultaneously pressing the **LINE** switch. This places the printer in the USER DOWNLOAD mode as signified by a "User Download" displayed on the LCD panel.



USER DOWNLOAD

You will hear a single "beep" signifying the printer is in the User Download mode.

4. Press the **LINE** key to place the printer in the On-Line mode.
NOTE: There is no visual indication (nothing displays) that you have performed this operation, however, the printer is now ready to receive the download command data stream.
5. Send the appropriate data stream to the printer, (see example, next page).

Download Procedure (Cont)

6. After the command has been sent, the unit will beep and print a status label. If it does not beep and print the label, the printer did not accept the data.
7. If the printer does not beep and print a setting label, turn the printer off, check your download command stream for errors and correct if necessary. Then start the download process over at Step 1.
8. If the custom codes are correct, press the **FEED** key to accept them and terminate the download process. If they are incorrect, turn the unit off without pressing the **FEED** key and begin the download process again at Step 1.

Example:

Command Structure

<ESC>LD,a,b,c,d,e,f,g,h,i

- | | | |
|---|---|--|
| a | = | Replacement character for STX in ASCII or hex format |
| b | = | Replacement character for ETX in ASCII or hex format |
| c | = | Replacement character for ESC in ASCII or hex format |
| d | = | Replacement character for ENQ in ASCII or hex format |
| e | = | Replacement character for CAN in ASCII or hex format |
| f | = | Replacement character for NULL in ASCII or hex format |
| g | = | Replacement character for OFFLINE in ASCII or hex format |
| h | = | Auto-Online. Printer powers up in the Online mode. |
| | | 0 = Yes |
| | | 1 = No |
| i | = | Zero Slash. Places a slash through the "0" character. |
| | | 0 = Yes |
| | | 1 = No |

Example: <ESC>LD,{,},%,#,&,* ,~,0,0

Placement: Immediately following the <ESC>A Start command and in an independent data stream.

Default: Standard Protocol command codes

Command Function

Allows the user to define custom Protocol Command codes.

Printer Input

Allows the user to define custom Protocol Command codes.

{^A^LD,{,},%,#,&,* ,~,0,0^Z}

(Next Page)

Printer Output

A Protocol Command code status label will be printed as a result of a successful download of a custom set of Protocol Command codes.



```
STX = 7B      ETX = 7D      ESC = 25
ENQ = 23      CAN = 26      NULL = 2A
OFFLINE = 7E
AUTO ONLINE =      YES
ZERO SLASH =      YES
```

Press the "FEED" key to activate
the User Default or power the
printer off to ignore them.

Factory Resets

The Factory Reset Mode allows you to:

- *Factory Test Print*
- *EEProm Clear All*
- *Clear Head Counters*
- *Clear Cutter Counter*



FACTORY TEST PRINT

Factory Test Print

To initiate a test print, perform the following steps.

STEP	PROCEDURE
1.	Record all current dip switch positions, then place all switches in the OFF position.
2.	Place the DSW2-5 in the ON or up position.
3.	Place the print head in the open position. Keeping both the LINE and FEED keys depressed, power on the printer.
4.	<p>Upon hearing the audible tone, release the LINE and FEED keys. Place the print head back in the closed position and DSW2-5 in the OFF or down position and the display will change FROM:</p> <div style="display: flex; align-items: center; justify-content: center;"> <div style="border: 1px solid black; padding: 5px; margin-right: 20px;">HEAD OPEN</div> <div style="font-size: 2em; margin-right: 10px;">→</div> <div style="border: 1px solid black; padding: 5px;">FACTORY MODE</div> </div>
5.	<p>Press the FEED button once. Verify display: "COUNTER CLEAR NON".</p> <div style="border: 1px solid black; padding: 5px; margin-left: 100px; text-align: center;"> COUNTER CLEAR NON </div>
6.	<p>Press FEED button to initialize reset. Verify display: "FACTORY TEST PRINT".</p> <div style="display: flex; align-items: center; justify-content: center;"> <div style="border: 1px solid black; padding: 5px; margin-right: 20px; text-align: center;"> FACTORY TEST PRINT </div> <div style="text-align: left;"> <p>See PAGE 7-1 For Example</p> </div> </div> <p>After a slight pause, a blank label will feed out followed by a factory test print.</p> <p>Warning: This test activates all the heating elements on the print head and therefore should be used for testing purposes only with full width labels to avoid damaging the print head.</p>
7.	Power OFF the printer and confirm that all switches are in the OFF or down position.

EEPROM Clear All

To reset the printer to the factory settings, perform the following steps.

Caution: *Resetting the printer will clear all registers.*

STEP	PROCEDURE
1.	Record all current dip switch positions, then place all switches in the OFF position.
2.	Place the DSW2-5 in the ON or up position.
3.	Place the print head in the open position. Keeping both the LINE and FEED keys depressed, power on the printer.
4.	<p>Upon hearing the audible tone, release the LINE and FEED keys. Place the print head back in the closed position and DSW2-5 in the OFF or down position and the display will change FROM:</p> <div style="display: flex; align-items: center; justify-content: center;"> <div style="border: 1px solid black; padding: 5px; margin-right: 20px;">HEAD OPEN</div> <div style="font-size: 2em; margin-right: 10px;">→</div> <div style="border: 1px solid black; padding: 5px;">FACTORY MODE</div> </div>
5.	<p>Press the FEED button once. Verify display: "COUNTER CLEAR NON".</p> <div style="border: 1px solid black; padding: 5px; margin-left: 100px; text-align: center;"> COUNTER CLEAR NON </div>
6.	<p>Press the LINE button once. Verify display: "COUNTER CLEAR ALL".</p> <div style="border: 1px solid black; padding: 5px; margin-left: 100px; text-align: center;"> COUNTER CLEAR ALL </div>
7.	<p>Press FEED button to initialize reset. Verify display: "FACTORY TEST PRINT".</p> <div style="display: flex; align-items: center; justify-content: center;"> <div style="border: 1px solid black; padding: 5px; margin-right: 20px; text-align: center;"> FACTORY TEST PRINT </div> <div style="text-align: right;"> <p>See PAGE 7-1 For Example</p> </div> </div>
	<p>After a slight pause, (1) blank label will feed out followed by a factory test print.</p> <p>Warning: This test activates all the heating elements on the print head and therefore should be used for testing purposes only with full width labels to avoid damaging the print head.</p>
8.	Verify that the counters on test print have reset to 0.0 km.
9.	Power OFF the printer and confirm that all switches are in the OFF or down position.

Clear Counter Heads

STEP	PROCEDURE
1.	Record all current dip switch positions, then place all switches in the OFF position.
2.	Place the DSW2-5 in the ON or up position.
3.	Place the print head in the open position. Keeping both the LINE and FEED keys depressed, power on the printer.
4.	Upon hearing the audible tone, release the LINE and FEED keys. Place the print head back in the closed position and DSW2-5 in the OFF or down position and the display will change FROM: <div style="display: flex; justify-content: space-around; align-items: center; margin-top: 10px;"> <div style="border: 1px solid black; padding: 5px; text-align: center;">HEAD OPEN</div> <div style="font-size: 2em;">→</div> <div style="border: 1px solid black; padding: 5px; text-align: center;">FACTORY MODE</div> </div> <p style="text-align: right; margin-right: 100px;">TO:</p>
5.	Press the FEED button once. Verify display: " COUNTER CLEAR NON ". <div style="border: 1px solid black; padding: 5px; text-align: center; margin-top: 10px;">COUNTER CLEAR NON</div>
6.	Press the LINE button twice. Verify display: " COUNTER CLEAR HEAD ". <div style="border: 1px solid black; padding: 5px; text-align: center; margin-top: 10px;">COUNTER CLEAR HEAD</div>
7.	Press the FEED button to initialize reset. Verify display: " FACTORY TEST PRINT ". <div style="display: flex; justify-content: space-around; align-items: center; margin-top: 10px;"> <div style="border: 1px solid black; padding: 5px; text-align: center;">FACTORY TEST PRINT</div> <div style="text-align: right;">See PAGE 7-1 For Example</div> </div>
	After a slight pause, (1) blank label will feed out followed by a factory test print.
	Warning: This test activates all the heating elements on the print head and therefore should be used for testing purposes only with full width labels to avoid damaging the print head.
8.	Verify that the counters on test print have reset to 0.0 km.
9.	Power OFF the printer and confirm that all switches are in the OFF or down position.

Clear Cutter Counter

STEP	PROCEDURE
1.	Record all current dip switch positions, then place all switches in the OFF position.
2.	Place the DSW2-5 in the ON or up position.
3.	Place the print head in the open position. Keeping both the LINE and FEED keys depressed, power on the printer.
4.	<p>Upon hearing the audible tone, release the LINE and FEED keys. Place the print head back in the closed position and DSW2-5 in the OFF or down position and the display will change FROM:</p> <div style="display: flex; align-items: center; justify-content: center;"> <div style="border: 1px solid black; padding: 5px; margin-right: 20px;">HEAD OPEN</div> <div style="font-size: 2em; margin-right: 10px;">→</div> <div style="border: 1px solid black; padding: 5px;">FACTORY MODE</div> </div> <p style="text-align: right; margin-right: 100px;">TO:</p>
5.	<p>Press the FEED button once. Verify display: "COUNTER CLEAR NON".</p> <div style="border: 1px solid black; padding: 5px; text-align: center; margin-left: 100px;"> COUNTER CLEAR NON </div>
6.	<p>Press the LINE button 3 times. Verify display: "COUNTER CLEAR CUT".</p> <div style="border: 1px solid black; padding: 5px; text-align: center; margin-left: 100px;"> COUNTER CLEAR CUT </div>
7.	<p>Press the FEED button to initialize reset. Verify display: "FACTORY TEST PRINT".</p> <div style="display: flex; align-items: center; justify-content: center; margin-left: 100px;"> <div style="border: 1px solid black; padding: 5px; text-align: center; margin-right: 20px;"> FACTORY TEST PRINT </div> <div style="text-align: left;"> <p>See PAGE 7-1 For Example</p> </div> </div> <p>After a slight pause, (1) blank label will feed out followed by a factory test print.</p> <p style="margin-left: 40px;">Warning: This test activates all the heating elements on the print head and therefore should be used for testing purposes only with full width labels to avoid damaging the print head.</p>
8.	Verify that the counters on test print have reset to 0.0 km.
9.	Power OFF the printer and confirm that all switches are in the OFF or down position.

